

L-LAS Series

▶ Laser Line Sensors

Line sensors are applied where precise positioning is required or where the dimensions of an object have to be determined with high accuracy, e.g. diameter of a wire.

The laser line sensors of L-LAS series offer various operating widths with a resolution of up to 1024 pixels. An analog output (voltage output and current output) informs about position and size of the object.

Furthermore, a digital output is available that offers information about quality and position of the object. By means of serial interface RS232 communication can be done via PC (or PLC + RS232 module).

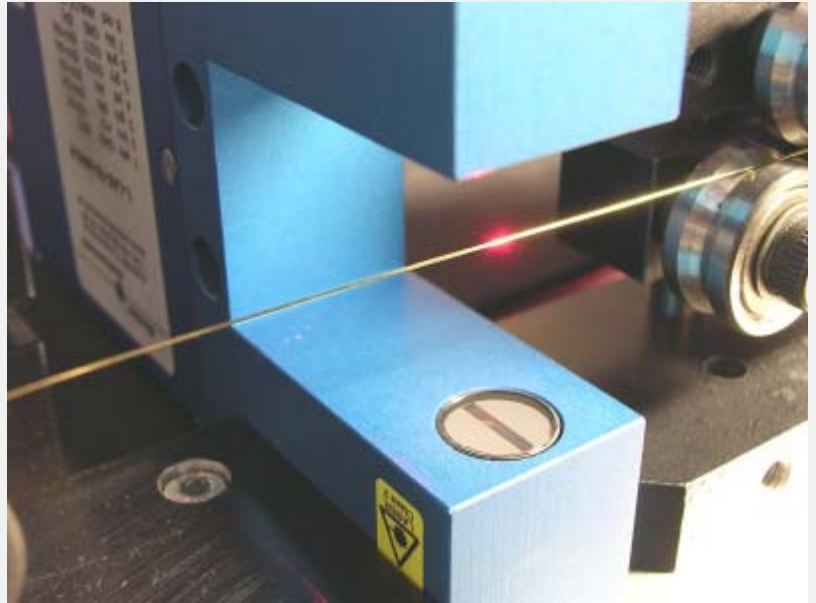

Characteristics

Functional principle of the sensor

L-LAS-TB laser line sensors are one-way light barriers. A laser collimator that generates a gap-shaped laser light curtain is used as a transmitter. Greatest importance was attached to keeping the divergence of this laser light curtain correspondingly low, i.e. to make sure that parallel laser light is provided.

The object is positioned between the transmitter and receiver unit of the sensor system; when the laser light curtain impinges on the object, a shadow of this object is created. The divergence of this shadow also is very small, i.e. the shadow is cast almost absolutely parallel. Then the laser light curtain (incl. shadow) impinges on the optical receiver. The task of the optical receiver is to project the laser light curtain onto the respective line sensor.

The L-LAS-LT laser line sensors operate according to the principle of triangulation, i.e. laser transmitter and receiver are arranged in a certain angle to each other. In the so-called reference distance the two optical axes of transmitter and receiver meet, the receiver signal lies in the center of the line receiver. Part of the laser light that is reflected from the measuring object is projected from the receiver optics onto the line detector. The distance between measuring object and sensor is calculated by means on an integrated controller.

Features

- Telecentric beam path
- Various models available (in fork shape or split shape)
- Various operating widths available
- Resolution up to 1024 pixels
- Insensitive to outside light due to interference filter, polarisation filter, and mechanical covers
- External TEACH-function
- Sturdy metal housing
- Parameterisable under Windows®, RS232 interface (USB adaptor available)
- Laser class 2 (visible laser light, 670 nm)
- Thickness measurement of objects respectively measurement of the distance between two objects
- Counting of objects in the lens coverage

Parameterization under Windows® with software L-LAS-TB-Scope, L-LAS-MS-Scope, L-LAS-LT-Scope, L-LAS-GD-Scope, LINE-Scope

The sensors can easily be set with the help of a Windows® user interface in which the sensor signals are displayed in numerical and graphical form; the user interface also provides various software algorithms and setting parameters.

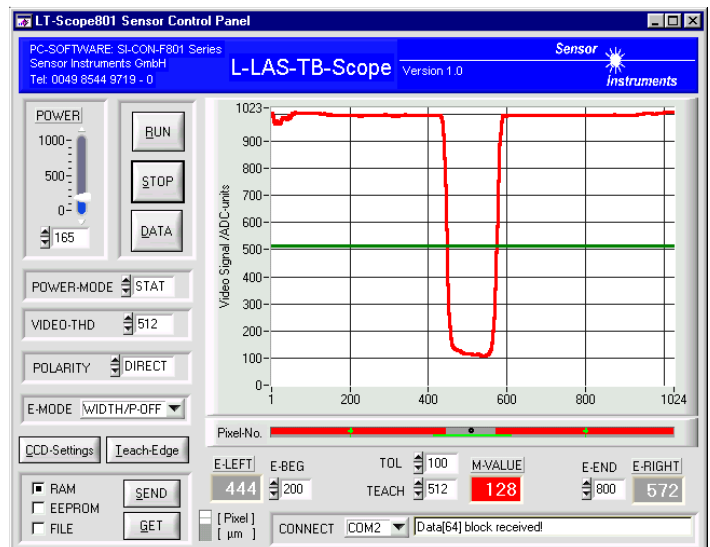

Parameters such as e.g.

- Threshold (video threshold)
- Laser power
- Averaging
- Polarity of output signal
- Display in mm, inch, or pixel
- Exposure time of laser line
- Evaluation algorithm (thickness measurement, „gap-size“ measurement, edge detection, etc.)
- Laser power correction
- Threshold correction (video threshold correction)

can be set with the software.



Product Line

Laser line sensor (through beam) - split version with separate electronic control unit - Measuring range typ. 8 mm
Product name

L-LAS-TB-8-CON1 (electronic control unit incl. software L-LAS-TB-Scope)
L-LAS-TB/90-8x1-T (transmitter frontend), **L-LAS-TB/90-8x1-R** (receiver frontend) or
L-LAS-TB/90-1x8-T (transmitter frontend), **L-LAS-TB/90-1x8-R** (receiver frontend)

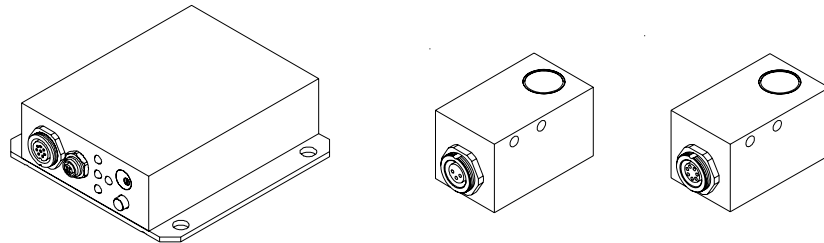

Laser	Semiconductor laser, 670 nm, DC operation, 1mW max. opt. power, class 2 laser product (DIN EN 60825)
Optical filter	Interference filter, red light filter, polarisation filter
Digital output (OUT0, OUT1)	pnp bright-/npn dark-switching or pnp dark-/npn bright-switching (adjustable via /PC)
Digital input (IN0)	Input voltage +Ub/0V, with protective circuit
Analog output (ANA)	0 ... +10V
Voltage supply	+12VDC ... +30VDC
Sensitivity setting	Adjustable via potentiometer TOL or under Windows® via PC
Laser power correction	Adjustable under Windows® via PC
Current consumption	Typ. 200 mA
Enclosure rating	Electronics: IP54, optics: IP67
Operating temperature range	-10°C ... +50°C
Housing material	Aluminum, anodized in blue
Housing dimensions	Electronics L-LAS-TB-8-CON1: approx. 90 mm x 65 mm x 27 mm (without flange connectors) Transmitter frontend L-LAS-TB-8-T: approx. 40 mm x 24 mm x 24 mm (without flange connectors) Receiver frontend L-LAS-TB-8-R: approx. 40 mm x 24 mm x 24 mm (without flange connectors)
Type of connector	Electronics L-LAS-TB-8-CON1: Connection to PLC/Power: 8-pole fem. connector Binder 712 Electronics L-LAS-TB-8-CON1: Connection to PC (RS232 interface): 4-pole fem. connector Binder 707 Transmitter frontend L-LAS-TB-8-T: 3-pole fem. connector Binder 712 Receiver frontend L-LAS-TB-8-R: 7-pole fem. connector Binder 712
Teach button / potentiometer	For teaching of set point value / For tolerance setting
LED display	LED red/green/red (upper tolerance threshold / tolerance window / lower tolerance threshold) LED yellow for sensor adjustment (multifunctional)
Scan frequency	Max. 100 Hz
Max. switching current	100 mA, short-circuit proof
Interface	RS232, parameterisable under Windows®
Connecting cables	L-LAS-TB-8-CON1 to PLC: cab-las8/SPS L-LAS-TB-8-CON1 to PC: cab-las4/PC L-LAS-TB-8-CON1 to L-LAS-TB/90-(8)-T: cab-las3-male L-LAS-TB-8-CON1 to L-LAS-TB/90-(8)-R: cab-las7-male
Output polarity	Bright-/dark-switching, switchable under Windows®
Measuring range / resolution	Typ. 8 mm / typ. 8 µm
EMC test acc. to	IEC - 801 ...



Product Line

Laser line sensor (through beam) - split version with separate electronic control unit - measuring range typ. 8 mm

Product name

L-LAS-TB-8-CON2 (electronic control unit incl. software L-LAS-TB-Scope)
L-LAS-TB-8x1-T08 (transmitter frontend), **L-LAS-TB-8x1-R18** (receiver frontend)

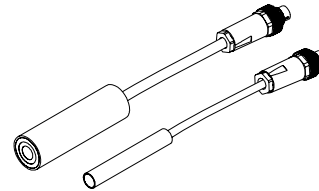
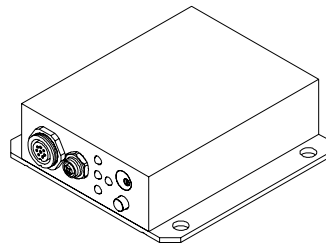

Laser	Semiconductor laser, 670 nm, DC operation, 1mW max. opt. power, class 2 laser product (DIN EN 60825)
Optical filter	Interference filter, red light filter, polarisation filter
Digital output (OUT0, OUT1)	pnp bright-/npn dark-switching or pnp dark-/npn bright-switching (adjustable via /PC)
Digital input (IN0)	Input voltage +Ub/0V, with protective circuit
Analog output (ANA)	0 ... +10V
Voltage supply	+12VDC ... +30VDC
Sensitivity setting	Adjustable via potentiometer TOL or under Windows® via PC
Laser power correction	Adjustable under Windows® via PC
Current consumption	Typ. 200 mA
Enclosure rating	Electronics: IP54, optics: IP67
Operating temperature range	-10°C ... +50°C
Housing material	Aluminum, anodized in blue
Housing dimensions	Electronics L-LAS-TB-8-CON2: approx. 80 mm x 80 mm x 25 mm (without flange connectors) Transmitter frontend L-LAS-TB-8x1-T08: approx. 52 mm x Ø 8 mm Receiver frontend L-LAS-TB-8x1-R18: approx. 80 mm x Ø 18 mm
Type of connector	Electronics L-LAS-TB-8-CON2: Connection to PLC/Power: 8-pole fem. connector Binder 712 Electronics L-LAS-TB-8-CON2: Connection to PC (RS232 interface): 4-pole fem. connector Binder 707 Transmitter frontend L-LAS-TB-8x1-T08: 3-pole fem. connector Binder 712 Receiver frontend L-LAS-TB-8x1-R18: 7-pole fem. connector Binder 712
Teach button / Potentiometer	For teaching of set point value / For tolerance setting
LED display	LED red/green/red (upper tolerance threshold / tolerance window / lower tolerance threshold) LED yellow for sensor adjustment (multifunctional)
Scan frequency	Max. 100 Hz
Max. switching current	100 mA, short-circuit proof
Interface	RS232, parameterisable under Windows®
Connecting cables	L-LAS-TB-8-CON2 to PLC: cab-las8/SPS L-LAS-TB-8-CON2 to PC: cab-las4/PC L-LAS-TB-8-CON2 to L-LAS-TB-8x1-T08: cab-las3-m/f L-LAS-TB-8-CON2 to L-LAS-TB-8x1-R18: cab-col5
Output polarity	Bright-/dark-switching, switchable under Windows®
Measuring range / resolution	Typ. 8 mm / typ. 8 µm
EMC test acc. to	IEC - 801 ...



Product Line

Laser line sensor (through beam) - split version with separate electronic control unit - measuring range typ. 12 mm
Product name

L-LAS-TB-12-CON1 (electronic control unit incl. software L-LAS-TB-Scope)
L-LAS-TB/90-12x1-T (transmitter frontend), **L-LAS-TB/90-12x1-R** (receiver frontend) or
L-LAS-TB/90-1x12-T (transmitter frontend), **L-LAS-TB/90-1x12-R** (receiver frontend)

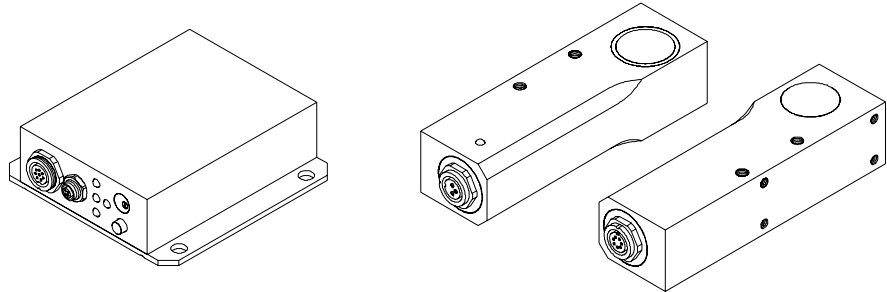

Laser	Semiconductor laser, 670 nm, DC operation, 1mW max. opt. power, class 2 laser product (DIN EN 60825)
Optical filter	Interference filter, red light filter, polarisation filter
Digital output (OUT0, OUT1)	pnp bright-/npn dark-switching or pnp dark-/npn bright-switching (adjustable via /PC)
Digital input (IN0)	Input voltage +Ub/0V, with protective circuit
Analog output (ANA)	0 ... +10V
Voltage supply	+12VDC ... +30VDC
Sensitivity setting	Adjustable via potentiometer TOL or under Windows® via PC
Laser power correction	Adjustable under Windows® via PC
Current consumption	Typ. 200 mA
Enclosure rating	Electronics: IP54, optics: IP67
Operating temperature range	-10°C ... +50°C
Housing material	Aluminum, anodized in blue
Housing dimensions	Electronics L-LAS-TB-12-CON1: approx. 90 mm x 65 mm x 27 mm (without flange connectors) Transmitter frontend L-LAS-TB/90-(12)-T: approx. 100 mm x 24 mm x 30 mm Receiver frontend L-LAS-TB/90-(12)-R: approx. 100 mm x 24 mm x 30 mm
Type of connector	Electronics L-LAS-TB-12-CON1: Connection to PLC/Power: 8-pol fem. connector Binder 712 Electronics L-LAS-TB-12-CON1: Connection to PC (RS232 interface): 4-pole fem. conn. Binder 707 Transmitter frontend L-LAS-TB/90-(12)-T: 3-pole fem. connector Binder 712 Receiver frontend L-LAS-TB/90-(12)-R: 7-pole fem. connector Binder 712
Teach button / Potentiometer	For teaching of set point value / For tolerance setting
LED display	LED red/green/red (upper tolerance threshold / tolerance window / lower tolerance threshold) LED yellow for sensor adjustment (multifunctional)
Scan frequency	Max. 100 Hz
Max. switching current	100 mA, short-circuit proof
Interface	RS232, parameterisable under Windows®
Connecting cables	L-LAS-TB-12-CON1 to PLC: cab-las8/SPS L-LAS-TB-12-CON1 to PC: cab-las4/PC L-LAS-TB-12-CON1 to L-LAS-TB/90-(12)-T: cab-las3-m/f L-LAS-TB-12-CON1 to L-LAS-TB/90-(12)-R: cab-col5
Output polarity	Bright-/dark-switching, switchable under Windows®
Measuring range / resolution	Typ. 12 mm / typ. 25 µm
EMC test acc. to	IEC - 801 ... CE



Laser line sensor (through beam) - split version with separate electronic control unit - measuring range typ. 12.8 mm

Product name

L-LAS-TB-12-T (transmitter)
L-LAS-TB-12-R (receiver incl. software L-LAS-TB-Scope)

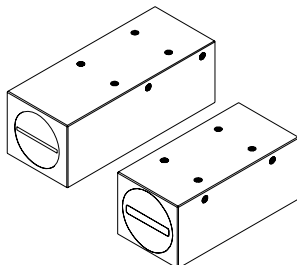

Laser	Semiconductor laser, 670 nm, DC operation, 1mW max. opt. power, class 2 laser product (DIN EN 60825)
Optical filter	Interference filter, red light filter, polarisation filter
Digital output (OUT0, OUT1)	pnp bright-/npn dark-switching or pnp dark-/npn bright-switching (adjustable via /PC)
Digital input (IN0)	Input voltage +Ub/0V, with protective circuit
Analog output (ANA)	0 ... +10V
Voltage supply	+12VDC ... +30VDC
Sensitivity setting	Adjustable via potentiometer TOL or under Windows® via PC
Laser power correction	Adjustable under Windows® via PC
Current consumption	Typ. 200 mA
Enclosure rating	Electronics: IP54, optics: IP67
Operating temperature range	-10°C ... +50°C
Housing material	Aluminum, anodized in blue
Housing dimensions	Transmitter L-LAS-TB-12-T: approx. 110 mm x 34 mm x 34 mm (without flange connectors) Receiver L-LAS-TB-12-R: approx. 90 mm x 40 mm x 40 mm (without flange connectors)
Type of connector	Transmitter L-LAS-TB-12-T: 3-pole fem. connector Binder 712 Receiver L-LAS-TB-12-R: 3-pole fem. connector Binder 712 Receiver L-LAS-TB-12-R: 4-pole fem. connector Binder 707 Receiver L-LAS-TB-12-R: 8-pole fem. connector Binder 712
Teach button	For teaching of set point value
Potentiometer	For tolerance setting
LED display	LED red/green/red (upper tolerance threshold / tolerance window / lower tolerance threshold) LED yellow for sensor adjustment (multifunctional)
Scan frequency	Max. 100 Hz
Max. switching current	100 mA, short-circuit proof
Interface	RS232, parameterisable under Windows®
Connecting cables	L-LAS-TB-12-T to L-LAS-TB-12-R: cab-las3-male L-LAS-TB-12-R to PLC: cab-las8/SPS L-LAS-TB-12-R to PC: cab-las4/PC
Output polarity	Bright-/dark-switching, switchable under Windows®
Measuring range	Typ. 12.8 mm
Resolution	Typ. 25 µm
EMC test acc. to	IEC - 801 ...



Laser line sensor (through beam) - split version - measuring range typ. 25 mm

Product name

L-LAS-TB-25-T (transmitter)
L-LAS-TB-25-R (receiver incl. software L-LAS-TB-Scope)

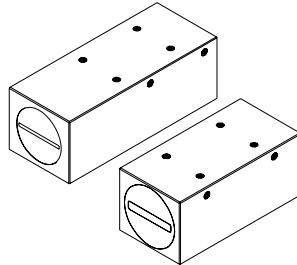

Laser	Semiconductor laser, 670 nm, DC operation, 1mW max. opt. power, class 2 laser product (DIN EN 60825)
Optical filter	Interference filter, red light filter, polarisation filter
Digital output (OUT0, OUT1)	pnp bright-/npn dark-switching or pnp dark-/npn bright-switching (adjustable via /PC)
Digital input (IN0)	Input voltage +Ub/0V, with protective circuit
Analog output (ANA)	0 ... +10V
Voltage supply	+12VDC ... +30VDC
Sensitivity setting	Adjustable via potentiometer TOL or under Windows® via PC
Laser power correction	Adjustable under Windows® via PC
Current consumption	Typ. 200 mA
Enclosure rating	Electronics: IP54, optics: IP67
Operating temperature range	-10°C ... +50°C
Housing material	Aluminum, anodized in blue
Housing dimensions	Transmitter L-LAS-TB-25-T: approx. 110 mm x 34 mm x 34 mm (without flange connectors) Receiver L-LAS-TB-25-R: approx. 90 mm x 40 mm x 40 mm (without flange connectors)
Type of connector	Transmitter L-LAS-TB-25-T: 3-pole fem. connector Binder 712 Receiver L-LAS-TB-25-R: 3-pole fem. connector Binder 712 Receiver L-LAS-TB-25-R: 4-pole fem. connector Binder 707 Receiver L-LAS-TB-25-R: 8-pole fem. connector Binder 712
Teach button	For teaching of set point value
Potentiometer	For tolerance setting
LED display	LED red/green/red (upper tolerance threshold / tolerance window / lower tolerance threshold) LED yellow for sensor adjustment (multifunctional)
Scan frequency	Max. 100 Hz
Max. switching current	100 mA, short-circuit proof
Interface	RS232, parameterisable under Windows®
Connecting cables	L-LAS-TB-25-T to L-LAS-TB-25-R: cab-las3-male L-LAS-TB-25-R to PLC: cab-las8/SPS L-LAS-TB-25-R to PC: cab-las4/PC
Output polarity	Bright-/dark-switching, switchable under Windows®
Measuring range	Typ. 25 mm
Resolution	Typ. 25 µm
EMC test acc. to	IEC - 801 ...



Laser line sensor (through beam) - split version - measuring range typ. 35 mm

Product name

L-LAS-TB-35-T (transmitter)
L-LAS-TB-35-R (receiver incl. software L-LAS-TB-Scope)

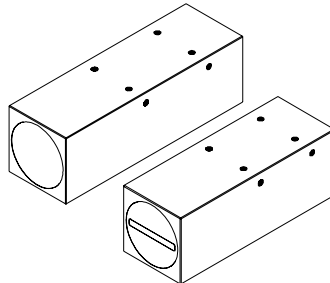

Laser	Semiconductor laser, 670 nm, DC operation, 1mW max. opt. power, class 2 laser product (DIN EN 60825)
Optical filter	Interference filter, red light filter, polarisation filter
Digital output (OUT0, OUT1)	pnp bright-/npn dark-switching or pnp dark-/npn bright-switching (adjustable via /PC)
Digital input (IN0)	Input voltage +Ub/0V, with protective circuit
Analog output (ANA)	0 ... +10V
Voltage supply	+12VDC ... +30VDC
Sensitivity setting	Adjustable via potentiometer TOL or under Windows® via PC
Laser power correction	Adjustable under Windows® via PC
Current consumption	Typ. 200 mA
Enclosure rating	Electronics: IP54, optics: IP67
Operating temperature range	-10°C ... +50°C
Housing material	Aluminum, anodized in blue
Housing dimensions	Transmitter L-LAS-TB-35-T: approx. 155 mm x 50 mm x 50 mm (without flange connectors) Receiver L-LAS-TB-35-R: approx. 135 mm x 50 mm x 50 mm (without flange connectors)
Type of connector	Transmitter L-LAS-TB-35-T: 3-pole fem. connector Binder 712 Receiver L-LAS-TB-35-R: 3-pole fem. connector Binder 712 Receiver L-LAS-TB-35-R: 4-pole fem. connector Binder 707 Receiver L-LAS-TB-35-R: 8-pole fem. connector Binder 712
Teach button	For teaching of set point value
Potentiometer	For tolerance setting
LED display	LED red/green/red (upper tolerance threshold / tolerance window / lower tolerance threshold) LED yellow for sensor adjustment (multifunctional)
Scan frequency	Max. 100 Hz
Max. switching current	100 mA, short-circuit proof
Interface	RS232, parameterisable under Windows®
Connecting cables	L-LAS-TB-35-T to L-LAS-TB-35-R: cab-las3-male L-LAS-TB-35-R to PLC: cab-las8/SPS L-LAS-TB-35-R to PC: cab-las4/PC
Output polarity	Bright-/dark-switching, switchable under Windows®
Measuring range	Typ. 35 mm
Resolution	Typ. 35 µm
EMC test acc. to	IEC - 801 ...



Product Line

Laser line sensor (through beam) - split version - measuring range typ. 50 mm

Product name

L-LAS-TB-50-T (transmitter)
L-LAS-TB-50-R (receiver incl. software L-LAS-TB-Scope)

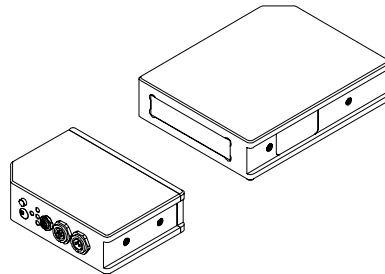

Laser	Semiconductor laser, 670 nm, DC operation, 1mW max. opt. power, class 2 laser product (DIN EN 60825)
Optical filter	Interference filter, red light filter, polarisation filter
Digital output (OUT0, OUT1)	pnp bright-/npn dark-switching or pnp dark-/npn bright-switching (adjustable via /PC)
Digital input (IN0)	Input voltage +Ub/0V, with protective circuit
Analog output (ANA)	0 ... +10V
Voltage supply	+12VDC ... +30VDC
Sensitivity setting	Adjustable via potentiometer TOL or under Windows® via PC
Laser power correction	Adjustable under Windows® via PC
Current consumption	Typ. 200 mA
Enclosure rating	Electronics: IP54, optics: IP67
Operating temperature range	-10°C ... +50°C
Housing material	Aluminum, anodized in blue
Housing dimensions	Transmitter L-LAS-TB-50-T: approx. 210 mm x 70 mm x 30 mm (without flange connectors) Receiver L-LAS-TB-50-R: approx. 175 mm x 70 mm x 30 mm (without flange connectors)
Type of connector	Transmitter L-LAS-TB-50-T: 3-pole fem. connector Binder 712 Receiver L-LAS-TB-50-R: 3-pole fem. connector Binder 712 Receiver L-LAS-TB-50-R: 4-pole fem. connector Binder 707 Receiver L-LAS-TB-50-R: 8-pole fem. connector Binder 712
Teach button	For teaching of set point value
Potentiometer	For tolerance setting
LED display	LED red/green/red (upper tolerance threshold / tolerance window / lower tolerance threshold) LED yellow for sensor adjustment (multifunctional)
Scan frequency	Max. 100 Hz
Max. switching current	100 mA, short-circuit proof
Interface	RS232, parameterisable under Windows®
Connecting cables	L-LAS-TB-50-T to L-LAS-TB-50-R: cab-las3-male L-LAS-TB-50-R to PLC: cab-las8/SPS L-LAS-TB-50-R to PC: cab-las4/PC
Output polarity	Bright-/dark-switching, switchable under Windows®
Measuring range	Typ. 50 mm
Resolution	Typ. 50 µm
EMC test acc. to	IEC - 801 ...



Product Line

Laser line sensor (through beam) - split version - measuring range typ. 75 mm

Product name

L-LAS-TB-75-T (transmitter)
L-LAS-TB-75-R (receiver incl. software L-LAS-TB-Scope)

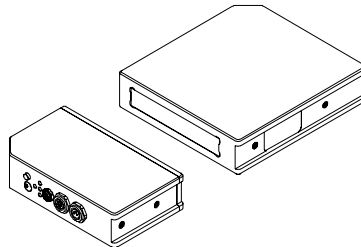

Laser	Semiconductor laser, 670 nm, DC operation, 1mW max. opt. power, class 2 laser product (DIN EN 60825)
Optical filter	Interference filter, red light filter, polarisation filter
Digital output (OUT0, OUT1)	pnp bright-/npn dark-switching or pnp dark-/npn bright-switching (adjustable via /PC)
Digital input (IN0)	Input voltage +Ub/0V, with protective circuit
Analog output (ANA)	0 ... +10V
Voltage supply	+12VDC ... +30VDC
Sensitivity setting	Adjustable via potentiometer TOL or under Windows® via PC
Laser power correction	Adjustable under Windows® via PC
Current consumption	Typ. 200 mA
Enclosure rating	Electronics: IP54, optics: IP67
Operating temperature range	-10°C ... +50°C
Housing material	Aluminum, anodized in blue
Housing dimensions	Transmitter L-LAS-TB-75-T: approx. 130 mm x 120 mm x 30 mm (without flange connectors) Receiver L-LAS-TB-75-R: approx. 70 mm x 120 mm x 30 mm (without flange connectors)
Type of connector	Transmitter L-LAS-TB-75-T: 3-pole fem. connector Binder 712 Receiver L-LAS-TB-75-R: 3-pole fem. connector Binder 712 Receiver L-LAS-TB-75-R: 4-pole fem. connector Binder 707 Receiver L-LAS-TB-75-R: 8-pole fem. connector Binder 712
Teach button	For teaching of set point value
Potentiometer	For tolerance setting
LED display	LED red/green/red (upper tolerance threshold / tolerance window / lower tolerance threshold) LED yellow for sensor adjustment (multifunctional)
Scan frequency	Max. 100 Hz
Max. switching current	100 mA, short-circuit proof
Interface	RS232, parameterisable under Windows®
Connecting cables	L-LAS-TB-75-T to L-LAS-TB-75-R: cab-las3-male L-LAS-TB-75-R to PLC: cab-las8/SPS L-LAS-TB-75-R to PC: cab-las4/PC
Output polarity	Bright-/dark-switching, switchable under Windows®
Measuring range	Typ. 75 mm
Resolution	Typ. 75 µm
EMC test acc. to	IEC - 801 ...



Product Line

Laser line sensor (through beam) - split version - measuring range typ. 100 mm
Product name

L-LAS-TB-100-T (transmitter)
L-LAS-TB-100-R (receiver incl. software L-LAS-TB-Scope)

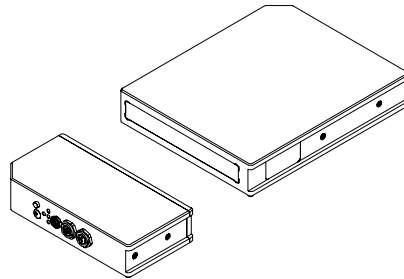

Laser	Semiconductor laser, 670 nm, DC operation, 1mW max. opt. power, class 2 laser product (DIN EN 60825)
Optical filter	Interference filter, red light filter, polarisation filter
Digital output (OUT0, OUT1)	pnp bright-/npn dark-switching or pnp dark-/npn bright-switching (adjustable via /PC)
Digital input (IN0)	Input voltage +Ub/0V, with protective circuit
Analog output (ANA)	0 ... +10V
Voltage supply	+12VDC ... +30VDC
Sensitivity setting	Adjustable via potentiometer TOL or under Windows® via PC
Laser power correction	Adjustable under Windows® via PC
Current consumption	Typ. 200 mA
Enclosure rating	Electronics: IP54, optics: IP67
Operating temperature range	-10°C ... +50°C
Housing material	Aluminum, anodized in blue
Housing dimensions	Transmitter L-LAS-TB-100-T: approx. 170 mm x 140 mm x 30 mm (without flange connectors) Receiver L-LAS-TB-100-R: approx. 70 mm x 140 mm x 30 mm (without flange connectors)
Type of connector	Transmitter L-LAS-TB-100-T: 3-pole fem. connector Binder 712 Receiver L-LAS-TB-100-R: 3-pole fem. connector Binder 712 Receiver L-LAS-TB-100-R: 4-pole fem. connector Binder 707 Receiver L-LAS-TB-100-R: 8-pole fem. connector Binder 712
Teach button	For teaching of set point value
Potentiometer	For tolerance setting
LED display	LED red/green/red (upper tolerance threshold / tolerance window / lower tolerance threshold) LED yellow for sensor adjustment (multifunctional)
Scan frequency	Max. 100 Hz
Max. switching current	100 mA, short-circuit proof
Interface	RS232, parameterisable under Windows®
Connecting cables	L-LAS-TB-100-T to L-LAS-TB-100-R: cab-las3-male L-LAS-TB-100-R to PLC: cab-las8/SPS L-LAS-TB-100-R to PC: cab-las4/PC
Output polarity	Bright-/dark-switching, switchable under Windows®
Measuring range	Typ. 100 mm
Resolution	Typ. 100 µm
EMC test acc. to	IEC - 801 ...

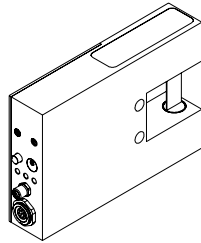

Product Line

Laser line sensor (through beam) - fork version - measuring range typ. 8 mm
Product name
L-LAS-TB-F-8x1-30/40 (incl. software L-LAS-TB-Scope) or
L-LAS-TB-F-1x8-30/40 (incl. software L-LAS-TB-Scope)

Laser	Semiconductor laser, 670 nm, DC operation, 1mW max. opt. power, class 2 laser product (DIN EN 60825)
Optical filter	Interference filter, red light filter, polarisation filter
Digital output (OUT0, OUT1)	pnp bright-/npn dark-switching or pnp dark-/npn bright-switching (adjustable via /PC)
Digital input (IN0)	Input voltage +Ub/0V, with protective circuit
Analog output (ANA)	0 ... +10V
Voltage supply	+12VDC ... +30VDC
Sensitivity setting	Adjustable via potentiometer TOL or under Windows® via PC
Laser power correction	Adjustable under Windows® via PC
Current consumption	Typ. 200 mA
Enclosure rating	Electronics: IP54, optics: IP67
Operating temperature range	-10°C ... +50°C
Housing material	Aluminum, anodized in blue
Housing dimensions	Approx. 115 mm x 78 mm x 24 mm (without flange connectors)
Type of connector	4-pole fem. connector Binder 707 8-pole fem. connector Binder 712
Teach button	For teaching of set point value
Potentiometer	For tolerance setting
LED display	LED red/green/red (upper tolerance threshold / tolerance window / lower tolerance threshold)
Scan frequency	Max. 100 Hz
Max. switching current	100 mA, short-circuit proof
Interface	RS232, parameterisable under Windows®
Connecting cables	To PLC: cab-las8/SPS To PC: cab-las4/PC
Output polarity	Bright-/dark-switching, switchable under Windows®
Measuring range	Typ. 8 mm
Resolution	Typ. 8 µm
EMC test acc. to	IEC - 801 ... CE

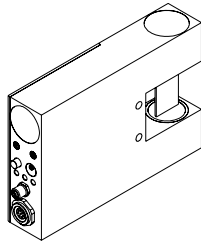

Product Line

Laser line sensor (through beam) - fork version - measuring range typ. 16 mm
Product name
L-LAS-TB-F-16x1-30/40 (incl. software L-LAS-TB-Scope) or
L-LAS-TB-F-1x16-30/40 (incl. software L-LAS-TB-Scope)

Laser	Semiconductor laser, 670 nm, DC operation, 1mW max. opt. power, class 2 laser product (DIN EN 60825)
Optical filter	Interference filter, red light filter, polarisation filter
Digital output (OUT0, OUT1)	pnp bright-/npn dark-switching or pnp dark-/npn bright-switching (adjustable via /PC)
Digital input (IN0)	Input voltage +Ub/0V, with protective circuit
Analog output (ANA)	0 ... +10V
Voltage supply	+12VDC ... +30VDC
Sensitivity setting	Adjustable via potentiometer TOL or under Windows® via PC
Laser power correction	Adjustable under Windows® via PC
Current consumption	Typ. 200 mA
Enclosure rating	Electronics: IP54, optics: IP67
Operating temperature range	-10°C ... +50°C
Housing material	Aluminum, anodized in blue
Housing dimensions	Approx. 115 mm x 78 mm x 24 mm (without flange connectors)
Type of connector	4-pole fem. connector Binder 707 8-pole fem. connector Binder 712
Teach button	For teaching of set point value
Potentiometer	For tolerance setting
LED display	LED red/green/red (upper tolerance threshold / tolerance window / lower tolerance threshold)
Scan frequency	Max. 100 Hz
Max. switching current	100 mA, short-circuit proof
Interface	RS232, parameterisable under Windows®
Connecting cables	To PLC: cab-las8/SPS To PC: cab-las4/PC
Output polarity	Bright-/dark-switching, switchable under Windows®
Measuring range	Typ. 16 mm
Resolution	Typ. 60 µm
EMC test acc. to	IEC - 801 ... CE

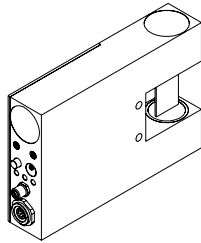

Product Line

Laser line sensor (through beam) - fork version - measuring range typ. 3 mm
Product name
L-LAS-TB-F-3x1-30/45-RO (incl. software L-LAS-TB-Scope) or
L-LAS-TB-F-1x3-30/45-RO (incl. software L-LAS-TB-Scope)

Laser	Semiconductor laser, 670 nm, DC operation, 1mW max. opt. power, class 2 laser product (DIN EN 60825)
Optical filter	Interference filter, red light filter, polarisation filter
Digital output (OUT0, OUT1)	pnp bright-/npn dark-switching or pnp dark-/npn bright-switching (adjustable via /PC)
Digital input (IN0)	Input voltage +Ub/0V, with protective circuit
Analog output (ANA)	0 ... +10V
Voltage supply	+12VDC ... +30VDC
Sensitivity setting	Adjustable via potentiometer TOL or under Windows® via PC
Laser power correction	Adjustable under Windows® via PC
Current consumption	Typ. 200 mA
Enclosure rating	Electronics: IP54, optics: IP67
Operating temperature range	-10°C ... +50°C
Housing material	Aluminum, anodized in blue
Housing dimensions	Approx. 120 mm x 70 mm x 24 mm (without flange connectors)
Type of connector	4-pole fem. connector Binder 707 8-pole fem. connector Binder 712
Teach button	For teaching of set point value
Potentiometer	For tolerance setting
LED display	LED red/green/red (upper tolerance threshold / tolerance window / lower tolerance threshold)
Scan frequency	Max. 100 Hz
Max. switching current	100 mA, short-circuit proof
Interface	RS232, parameterisable under Windows®
Connecting cables	To PLC: cab-las8/SPS To PC: cab-las4/PC
Output polarity	Bright-/dark-switching, switchable under Windows®
Measuring range	Typ. 3 mm
Resolution	Typ. 3 µm
EMC test acc. to	IEC - 801 ... CE



Product Line

Laser line sensor (through beam) - master/slave system - measuring range typ. 8 mm

Product name

L-LAS-TB-MS-8x1-40/40-MA (master)
 L-LAS-TB-MS-1x8-40/40-MA (master)
 (incl. software L-LAS-MS-Scope)

L-LAS-TB-MS-8x1-40/40-SL (slave) or
 L-LAS-TB-MS-1x8-40/40-SL (slave)

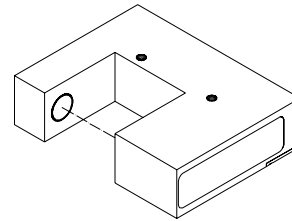
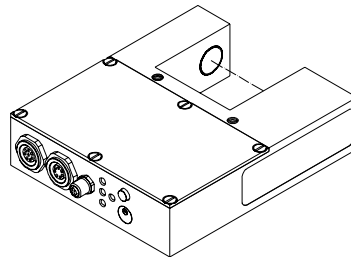

Laser	Semiconductor laser, 670 nm, DC operation, 1mW max. opt. power, class 2 laser product (DIN EN 60825)
Laser line	Visible laser line typ. 9.5 mm x 1.5 mm (red light 670 nm)
Optical filter	Interference filter, red light filter, polarisation filter
Analog output (ANA0)	0 ... +10V
Digital output (OUT0, OUT1)	pnp bright-/npn dark-switching or pnp dark-/npn bright-switching (adjustable via /PC)
Digital input (IN0)	Input voltage +Ub/0V, with protective circuit
Voltage supply	+12VDC ... +30VDC
Sensitivity setting	Adjustable via potentiometer TOL or under Windows® via PC
Laser power correction	Adjustable under Windows® via PC
Current consumption	Typ. 200 mA
Enclosure rating	Electronics: IP54, optics: IP67
Operating temperature range	-10°C ... +50°C
Housing material	Aluminum, anodized in blue
Housing dimensions	L-LAS-TB-MS-(8)-40/40-MA: approx. 100 mm x 85 mm x 24 mm (without flange connector) L-LAS-TB-MS-(8)-40/40-SL: approx. 70 mm x 85 mm x 24 mm (without flange connector)
Type of connector	L-LAS-TB-MS-(8)-40/40-MA: 8-pole fem. connector Binder 712 L-LAS-TB-MS-(8)-40/40-MA: 4-pole fem. connector Binder 707 L-LAS-TB-MS-(8)-40/40-MA: 7-pole fem. connector Binder 712 L-LAS-TB-MS-(8)-40/40-SL: 7-pole fem. connector Binder 712
Teach button / Potentiometer	For teaching of set point value / For tolerance setting
LED display	LED red/green/red (upper tolerance threshold / tolerance window / lower tolerance threshold) LED yellow for sensor adjustment (multifunctional)
Scan frequency	Max. 100 Hz
Max. switching current	100 mA, short-circuit proof
Interface	RS232, parameterisable under Windows®
Connecting cables	L-LAS-TB-MS-(8)-40/40-MA to PLC: cab-las8/SPS L-LAS-TB-MS-(8)-40/40-MA to PC: cab-las4/PC L-LAS-TB-MS-(8)-40/40-MA to L-LAS-TB-MS-(8)-40/40-SL: cab-las7-male
Output polarity	Bright-/dark-switching, switchable under Windows®
Measuring range	Typ. 8 mm
Resolution	Typ. 10 µm
EMC test acc. to	IEC - 801 ...



Product Line

Laser line sensor (through beam) - master/slave system - measuring range typ. 16 mm
Product name

L-LAS-TB-MS-16x1-40/40-MA (master)
L-LAS-TB-MS-1x16-40/40-MA (master)
 (incl. software L-LAS-MS-Scope)

L-LAS-TB-MS-16x1-40/40-SL (slave) or
L-LAS-TB-MS-1x16-40/40-SL (slave)

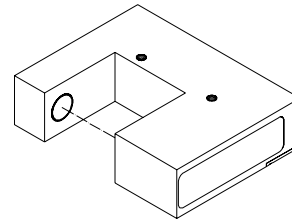
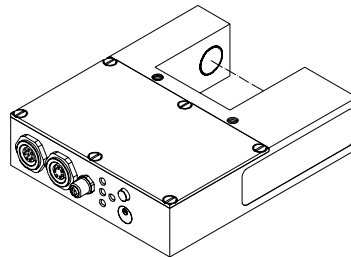

Laser	Semiconductor laser, 670 nm, DC operation, 1mW max. opt. power, class 2 laser product (DIN EN 60825)
Laser line	Visible laser line typ. 16 mm x 2 mm (red light 670 nm)
Optical filter	Interference filter, red light filter, polarisation filter
Analog output (ANA0)	0 ... +10V
Digital output (OUT0, OUT1)	pnp bright-/npn dark-switching or pnp dark-/npn bright-switching (adjustable via /PC)
Digital input (IN0)	Input voltage +Ub/0V, with protective circuit
Voltage supply	+12VDC ... +30VDC
Sensitivity setting	Adjustable via potentiometer TOL or under Windows® via PC
Laser power correction	Adjustable under Windows® via PC
Current consumption	Typ. 200 mA
Enclosure rating	Electronics: IP54, optics: IP67
Operating temperature range	-10°C ... +50°C
Housing material	Aluminum, anodized in blue
Housing dimensions	L-LAS-TB-MS-(16)-40/40-MA: approx. 100 mm x 85 mm x 24 mm (without flange connector) L-LAS-TB-MS-(16)-40/40-SL: approx. 70 mm x 85 mm x 24 mm (without flange connector)
Type of connector	L-LAS-TB-MS-(16)-40/40-MA: 8-pole fem. connector Binder 712 L-LAS-TB-MS-(16)-40/40-MA: 4-pole fem. connector Binder 707 L-LAS-TB-MS-(16)-40/40-MA: 7-pole fem. connector Binder 712 L-LAS-TB-MS-(16)-40/40-SL: 7-pole fem. connector Binder 712
Teach button / Potentiometer	For teaching of set point value / For tolerance setting
LED display	LED red/green/red (upper tolerance threshold / tolerance window / lower tolerance threshold) LED yellow for sensor adjustment (multifunctional)
Scan frequency	Max. 100 Hz
Max. switching current	100 mA, short-circuit proof
Interface	RS232, parameterisable under Windows®
Connecting cables	L-LAS-TB-MS-(16)-40/40-MA to PLC: cab-las8/SPS L-LAS-TB-MS-(16)-40/40-MA to PC: cab-las4/PC L-LAS-TB-MS-(16)-40/40-MA to L-LAS-TB-MS-(16)-40/40-SL: cab-las7-male
Output polarity	Bright-/dark-switching, switchable under Windows®
Measuring range	Typ. 16 mm
Resolution	Typ. 65 µm
EMC test acc. to	IEC - 801 ...



Product Line

Laser line sensor (through beam) - master/slave system with blast air connector - measuring range typ. 8 mm
Product name

L-LAS-TB-MS-8x1-200/40-MA-BL (master) **L-LAS-TB-MS-8x1-200/40-SL-BL** (slave) or
L-LAS-TB-MS-1x8-200/40-MA-BL (master) **L-LAS-TB-MS-1x8-200/40-SL-BL** (slave)
 (incl. software L-LAS-MS-Scope)

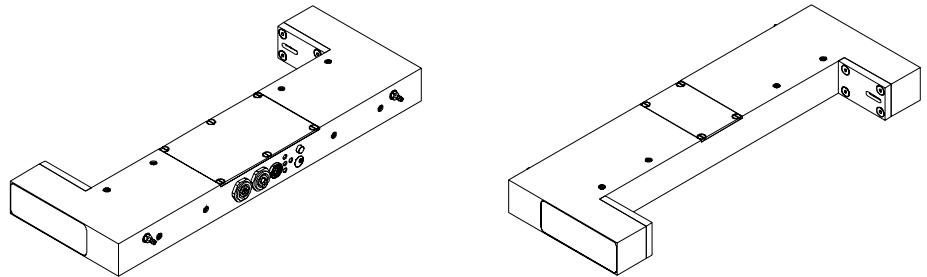

Laser	Semiconductor laser, 670 nm, DC operation, 1mW max. opt. power, class 2 laser product (DIN EN 60825)
Laser line	Visible laser line typ. 9.5 mm x 1.5 mm (red light 670 nm)
Optical filter	Interference filter, red light filter, polarisation filter
Analog output (ANA0)	0 ... +10V
Digital output (OUT0, OUT1)	pnp bright-/npn dark-switching or pnp dark-/npn bright-switching (adjustable via /PC)
Digital input (IN0)	Input voltage +Ub/0V, with protective circuit
Voltage supply	+12VDC ... +30VDC
Sensitivity setting	Adjustable via potentiometer TOL or under Windows® via PC
Laser power correction	Adjustable under Windows® via PC
Current consumption	Typ. 200 mA
Enclosure rating	Electronics: IP54, optics: IP67
Operating temperature range	-10°C ... +50°C
Housing material	Aluminum, anodized in blue
Housing dimensions	L-LAS-TB-MS-(8)-40/40-MA-BL: approx. 260 mm x 93 mm x 24 mm (without flange connector) L-LAS-TB-MS-(8)-40/40-SL-BL: approx. 260 mm x 93 mm x 24 mm (without flange connector)
Type of connector	L-LAS-TB-MS-(8)-40/40-MA-BL: 8-pole fem. connector Binder 712 L-LAS-TB-MS-(8)-40/40-MA-BL: 4-pole fem. connector Binder 707 L-LAS-TB-MS-(8)-40/40-MA-BL: 7-pole fem. connector Binder 712 L-LAS-TB-MS-(8)-40/40-SL-BL: 7-pole fem. connector Binder 712
Teach button / Potentiometer	For teaching of set point value / For tolerance setting
LED display	LED red/green/red (upper tolerance threshold / tolerance window / lower tolerance threshold) LED yellow for sensor adjustment (multifunctional)
Scan frequency	Max. 100 Hz
Max. switching current	100 mA, short-circuit proof
Interface	RS232, parameterisable under Windows®
Connecting cables	L-LAS-TB-MS-(8)-40/40-MA-SL-BL to PLC: cab-las8/SPS L-LAS-TB-MS-(8)-40/40-MA-SL-BL to PC: cab-las4/PC L-LAS-TB-MS-(8)-40/40-MA-SL-BL to L-LAS-TB-MS-(8)-40/40-SL-BL: cab-las7-male
Output polarity	Bright-/dark-switching, switchable under Windows®
Measuring range	Typ. 8 mm
Resolution	Typ. 10 µm
EMC test acc. to	IEC - 801 ...

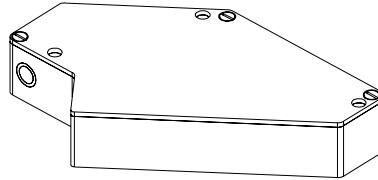
Laser line sensor (triangulation principle) - reference distance 37 mm - measuring range typ. 3 mm
Product name
L-LAS-LT-37 (incl. software L-LAS-LT-Scope)

Laser	Semiconductor laser, 670 nm, DC operation, 1mW max. opt. power, class 2 laser product (DIN EN 60825)
Optical filter	Interference filter, red light filter
Digital output (OUT0, OUT1)	pnp bright-/npn dark-switching or pnp dark-/npn bright-switching (adjustable via /PC)
Digital input (IN0)	Input voltage +Ub/0V, with protective circuit
Analog output (ANA)	0 ... +10V
Voltage supply	+12VDC ... +30VDC
Sensitivity setting	Adjustable via potentiometer TOL or under Windows® via PC
Laser power correction	Adjustable under Windows® via PC
Current consumption	Typ. 200 mA
Enclosure rating	Electronics: IP54, optics: IP67
Operating temperature range	-10°C ... +50°C
Housing material	Aluminum, anodized in blue
Housing dimensions	Approx. 130 mm x 85 mm x 25 mm (without flange connectors)
Type of connector	8-pole fem. connector Binder 712 (to PLC) 4-pole fem. connector Binder 707 (to PC)
Teach button	For teaching of set point value
Potentiometer	For tolerance setting
LED display	LED red/green/red (upper tolerance threshold / tolerance window / lower tolerance threshold) LED yellow for sensor adjustment (multifunctional)
Scan frequency	Max. 200 Hz / 400 Hz
Max. switching current	100 mA, short-circuit proof
Interface	RS232, parameterisable under Windows®
Connecting cables	To PLC: cab-las8/SPS To PC: cab-las4/PC
Output polarity	Bright-/dark-switching, switchable under Windows®
Reference distance	37 mm
Measuring range	Typ. 3 mm
Resolution	Typ. 3 µm
EMC test acc. to	IEC - 801 ... CE



Laser line sensor (triangulation principle) - reference distance 55 mm - measuring range typ. 10 mm

Product name

L-LAS-LT-55 (incl. software L-LAS-LT-Scope)

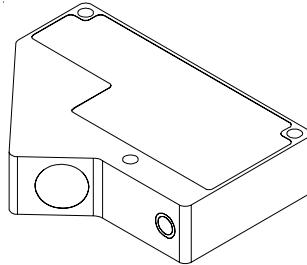

Laser	Semiconductor laser, 670 nm, DC operation, 1mW max. opt. power, class 2 laser product (DIN EN 60825)
Optical filter	Interference filter, red light filter
Digital output (OUT0, OUT1)	pnp bright-/npn dark-switching or pnp dark-/npn bright-switching (adjustable via /PC)
Digital input (IN0)	Input voltage +Ub/0V, with protective circuit
Analog output (ANA)	0 ... +10V
Voltage supply	+12VDC ... +30VDC
Sensitivity setting	Adjustable via potentiometer TOL or under Windows® via PC
Laser power correction	Adjustable under Windows® via PC
Current consumption	Typ. 200 mA
Enclosure rating	Electronics: IP54, optics: IP67
Operating temperature range	-10°C ... +50°C
Housing material	Aluminum, anodized in blue
Housing dimensions	Approx. 115 mm x 80 mm x 25 mm (without flange connectors)
Type of connector	8-pole fem. connector Binder 712 (to PLC) 4-pole fem. connector Binder 707 (to PC)
Teach button	For teaching of set point value
Potentiometer	For tolerance setting
LED display	LED red/green/red (upper tolerance threshold / tolerance window / lower tolerance threshold) LED yellow for sensor adjustment (multifunctional)
Scan frequency	Max. 200 Hz / 400 Hz
Max. switching current	100 mA, short-circuit proof
Interface	RS232, parameterisable under Windows®
Connecting cables	To PLC: cab-las8/SPS To PC: cab-las4/PC
Output polarity	Bright-/dark-switching, switchable under Windows®
Reference distance	55 mm
Measuring range	Typ. 10 mm
Resolution	Typ. 0,01 mm
EMC test acc. to	IEC - 801 ... CE

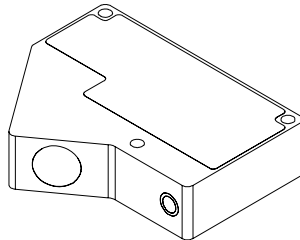

Product Line

Laser line sensor (triangulation principle) - reference distance 80 mm - measuring range typ. 20 mm
Product name**L-LAS-LT-80** (incl. software L-LAS-LT-Scope)

Laser	Semiconductor laser, 670 nm, DC operation, 1mW max. opt. power, class 2 laser product (DIN EN 60825)
Optical filter	Interference filter, red light filter
Digital output (OUT0, OUT1)	pnp bright-/npn dark-switching or pnp dark-/npn bright-switching (adjustable via /PC)
Digital input (IN0)	Input voltage +Ub/0V, with protective circuit
Analog output (ANA)	0 ... +10V
Voltage supply	+12VDC ... +30VDC
Sensitivity setting	Adjustable via potentiometer TOL or under Windows® via PC
Laser power correction	Adjustable under Windows® via PC
Current consumption	Typ. 200 mA
Enclosure rating	Electronics: IP54, optics: IP67
Operating temperature range	-10°C ... +50°C
Housing material	Aluminum, anodized in blue
Housing dimensions	Approx. 108 mm x 80 mm x 25 mm (without flange connectors)
Type of connector	8-pole fem. connector Binder 712 (to PLC) 4-pole fem. connector Binder 707 (to PC)
Teach button	For teaching of set point value
Potentiometer	For tolerance setting
LED display	LED red/green/red (upper tolerance threshold / tolerance window / lower tolerance threshold) LED yellow for sensor adjustment (multifunctional)
Scan frequency	Max. 200 Hz / 400 Hz
Max. switching current	100 mA, short-circuit proof
Interface	RS232, parameterisable under Windows®
Connecting cables	To PLC: cab-las8/SPS To PC: cab-las4/PC
Output polarity	Bright-/dark-switching, switchable under Windows®
Reference distance	80 mm
Measuring range	Typ. 20 mm
Resolution	Typ. 0,02 mm
EMC test acc. to	IEC - 801 ... CE

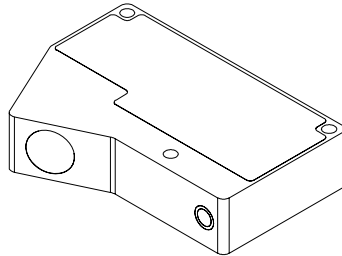

Product Line

Laser line sensor (triangulation principle) - reference distance 160 mm - measuring range typ. 80 mm
Product name**L-LAS-LT-160** (incl. software L-LAS-LT-Scope)

Laser	Semiconductor laser, 670 nm, DC operation, 1mW max. opt. power, class 2 laser product (DIN EN 60825)
Optical filter	Interference filter, red light filter
Digital output (OUT0, OUT1)	pnp bright-/npn dark-switching or pnp dark-/npn bright-switching (adjustable via /PC)
Digital input (IN0)	Input voltage +Ub/0V, with protective circuit
Analog output (ANA)	0 ... +10V
Voltage supply	+12VDC ... +30VDC
Sensitivity setting	Adjustable via potentiometer TOL or under Windows® via PC
Laser power correction	Adjustable under Windows® via PC
Current consumption	Typ. 200 mA
Enclosure rating	Electronics: IP54, optics: IP67
Operating temperature range	-10°C ... +50°C
Housing material	Aluminum, anodized in blue
Housing dimensions	Approx. 115 mm x 82 mm x 25 mm (without flange connectors)
Type of connector	8-pole fem. connector Binder 712 (to PLC) 4-pole fem. connector Binder 707 (to PC)
Teach button	For teaching of set point value
Potentiometer	For tolerance setting
LED display	LED red/green/red (upper tolerance threshold / tolerance window / lower tolerance threshold) LED yellow for sensor adjustment (multifunctional)
Scan frequency	Max. 200 Hz / 400 Hz
Max. switching current	100 mA, short-circuit proof
Interface	RS232, parameterisable under Windows®
Connecting cables	To PLC: cab-las8/SPS To PC: cab-las4/PC
Output polarity	Bright-/dark-switching, switchable under Windows®
Reference distance	160 mm
Measuring range	Typ. 80 mm
Resolution	Typ. 0,08 mm
EMC test acc. to	IEC - 801 ... CE



Laser line sensor (triangulation principle) - reference distance 200 mm - measuring range typ. 100 mm

Product name

L-LAS-LT-200 (incl. software L-LAS-LT-Scope)

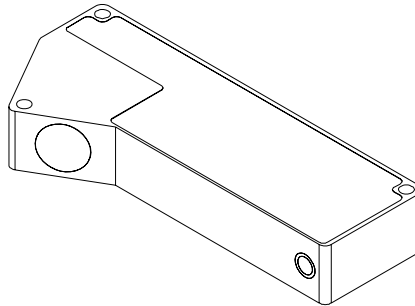

Laser	Semiconductor laser, 670 nm, DC operation, 1mW max. opt. power, class 2 laser product (DIN EN 60825)
Optical filter	Interference filter, red light filter
Digital output (OUT0, OUT1)	pnp bright-/npn dark-switching or pnp dark-/npn bright-switching (adjustable via /PC)
Digital input (IN0)	Input voltage +Ub/0V, with protective circuit
Analog output (ANA)	0 ... +10V
Voltage supply	+12VDC ... +30VDC
Sensitivity setting	Adjustable via potentiometer TOL or under Windows® via PC
Laser power correction	Adjustable under Windows® via PC
Current consumption	Typ. 200 mA
Enclosure rating	Electronics: IP54, optics: IP67
Operating temperature range	-10°C ... +50°C
Housing material	Aluminum, anodized in blue
Housing dimensions	Approx. 160 mm x 70 mm x 25 mm (without flange connectors)
Type of connector	8-pole fem. connector Binder 712 (to PLC) 4-pole fem. connector Binder 707 (to PC)
Teach button	For teaching of set point value
Potentiometer	For tolerance setting
LED display	LED red/green/red (upper tolerance threshold / tolerance window / lower tolerance threshold) LED yellow for sensor adjustment (multifunctional)
Scan frequency	Max. 200 Hz / 400 Hz
Max. switching current	100 mA, short-circuit proof
Interface	RS232, parameterisable under Windows®
Connecting cables	To PLC: cab-las8/SPS To PC: cab-las4/PC
Output polarity	Bright-/dark-switching, switchable under Windows®
Reference distance	200 mm
Measuring range	Typ. 100 mm
Resolution	Typ. 0,1 mm
EMC test acc. to	IEC - 801 ... CE



Laser line sensor for edge detection - reference distance typ. 150 mm

Product name

L-LAS-ED-1024/8-150 (incl. software LINE-Scope)

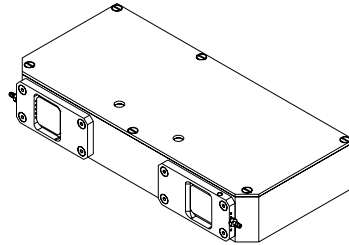

Laser	Semiconductor laser, 670 nm, DC-operation, 1mW max. opt. power, laser class 2 (DIN EN 60825).
Optical filter	Red light filter
Analog output (ANA)	0 ... +10V
Digital outputs (OUT0, OUT1)	pnp bright-/npn dark-switching or pnp dark-/npn bright-switching (adjustable via PC)
Digital inputs (IN0, IN1)	Input voltage +Ub/0V, with protective circuit
Voltage supply	+12VDC ... +30VDC
Sensitivity setting	Adjustable under Windows® on PC, average time 10 ms ... 500 ms
Laser power correction	Adjustable under Windows® on PC
Current consumption	Typ. 250 mA
Enclosure rating	Electronics: IP54, optics: IP67
Operating temperature range	-10°C ... +50°C
Housing material	Aluminum, anodized in blue
Dimensions sensor housing	Approx. 200 mm x 90 mm x 35 mm (without flange sockets)
Dimensions protective unit	Approx. 60 mm x 30 mm x 5 mm (PROTEC-ED-60/30 with blast air top)
Type of connector	8-pin female connector Binder 712 (PLC Power) 5-pin female connector Binder 702 (PC RS232) 9-pin SUB-D female connector (PROFIBUS)
LED display	2x LED yellow (distance > REF, distance < REF), 1x LED green/red (PROFIBUS POWER/STATUS)
Alteration switch	For change-over between PROFIBUS and RS232
Scan frequency	Max. 100 Hz
Max. switching current	100 mA, short-circuit-proof
Interface	RS232, parameterisable under Windows®, PROFIBUS/RS232 adaptor
Connecting cable	To PLC: cab-las8/SPS To PC: cab-las5/PC To PROFIBUS: cab-las9/DP
Output polarity	Bright-/dark-switching, adjustable under Windows®
Reference distance	Typ. 150 mm
Measuring range	Typ. 60 mm
Resolution	Typ. 0.1 mm
EMC test acc. to	IEC - 801 ...



Laser line sensor for detection of the position of a coated glass surface or for glass thickness measurement

Product name

L-LAS-GTM-256/16 (incl. software L-LAS-TB-Scope)

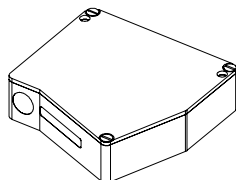

Laser	Semiconductor laser, 670 nm, DC-operation, 1mW max. opt. power, laser class 2 (DIN EN 60825).
Optical filter	Interference filter, red light filter
Analog output (ANA)	0 ... +10V
Digital outputs (OUT0, OUT1)	pnp bright-/npn dark-switching or pnp dark-/npn bright-switching (adjustable via PC)
Digital inputs (IN0, IN1)	Input voltage +Ub/0V, with protective circuit
Voltage supply	+12VDC ... +30VDC
Laser power correction	Adjustable under Windows® on PC
Current consumption	Typ. 200 mA
Enclosure rating	Electronics: IP54, optics: IP67
Operating temperature range	0°C ... +50°C
Housing material	Aluminum, anodized in blue
Housing dimensions	Approx. 80 mm x 65 mm (81,5 mm) x 22 mm (without flange sockets)
Type of connector	8-pin female connector Binder 712 (PLC/Power) 4-pin female connector Binder 707 (PC/RS232)
LED display	LED red/green/red (upper tolerance threshold / tolerance window / lower tolerance threshold) LED yellow for sensor adjustment (multifunctional)
Teach button	For teaching of set point value
Potentiometer	For tolerance setting
Measuring frequency	Typ. 200 Hz (without averaging)
Max. switching current	100 mA, short-circuit-proof
Interface	RS232, parameterisable under Windows®
Connecting cables	To PLC: cab-las8/SPS To PC: cab-las4/PC
Output polarity	Bright-/dark-switching, adjustable under Windows®
Reference distance	10 mm ... 80 mm, depends on the sensor adjustment to the object (position of angle)
Measuring range	Depends on the sensor adjustment to the object (position of angle)
Length of detector	Typ. 16 mm
EMC test acc. to	IEC - 801 ... CE

Application Examples

Monitoring the cutting edge of foils

The task is to check the cutting edge of foils during the cutting process, with an accuracy lying in the μm range.

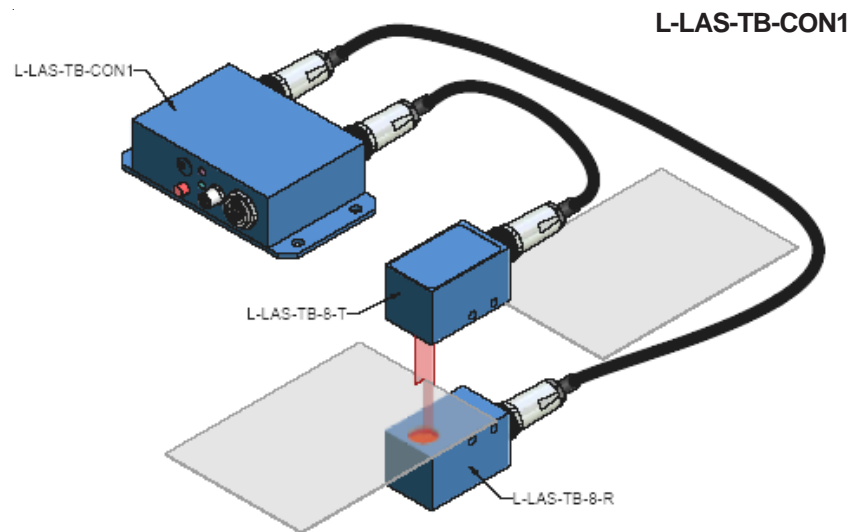
**Position checking of plastic foils directly before the welding process**

The position of the fed foil should be checked directly before two plastic foils are welded together.

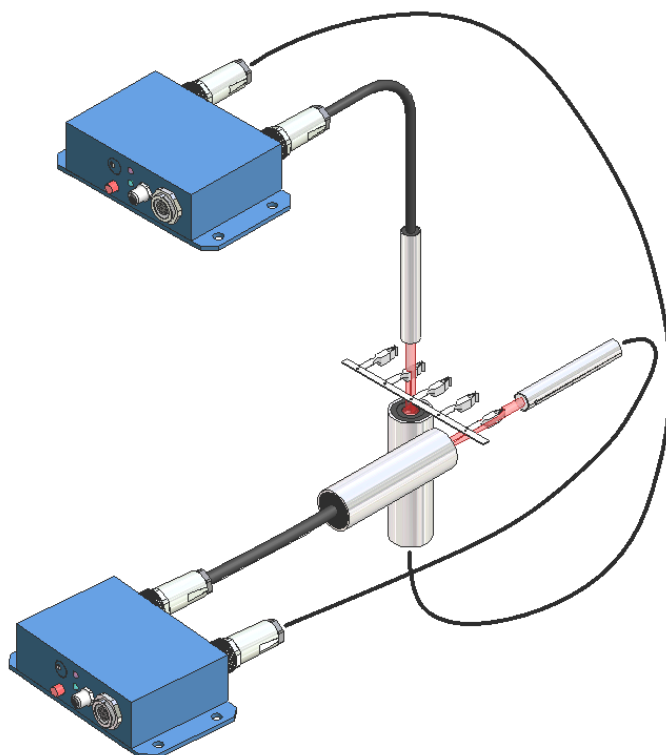
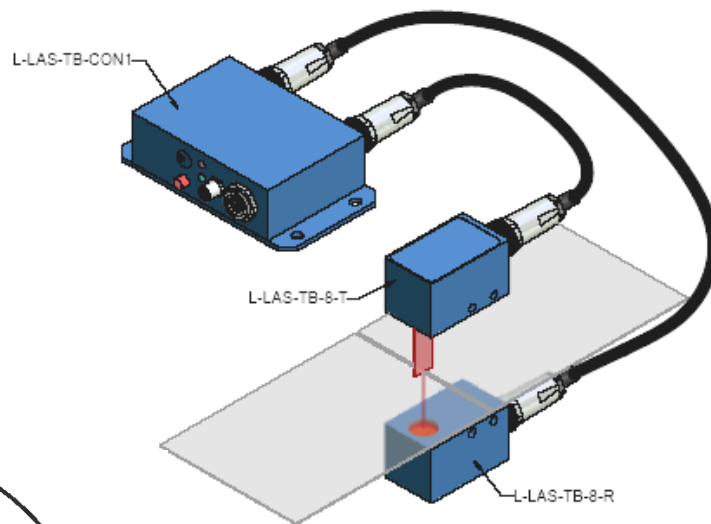
**L-LAS-TB-CON2**

Checking of the width of contact plugs during production process.

Gap-size measurement of contact plugs in the stamping industry.

Application Examples
Width measuring of objects of any width

The sensor system L-LAS-WDC-40/40-8 with two laser forks is used for this measuring task. One laser fork each is directed onto the right and left edge, respectively, of the object to be measured, with the yellow LEDs serving as setting aids: When the yellow LED goes off, approximately 50 % of the laser light curtain is covered.

For measuring objects of small width, the two laser forks are arranged at an angle to each other and can thus be pushed into each other. The system operates in a master-slave mode, i.e. the two line sensors are controlled, read out, and evaluated by way of an electronic control unit that is integrated in the master fork.

The two detected edges (left and right edge) provide information about the width of the object to be measured. The result is provided in analog form (4mA ... 20mA or 0V ... 10V) at the socket to the PLC, or in digital form as a serial signal at the RS232 interface. Furthermore, an OK/NOK signal (digital 0V/+24V) can be set by means of a tolerance window.

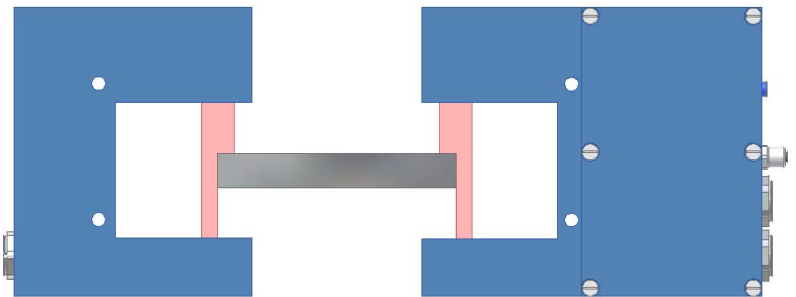
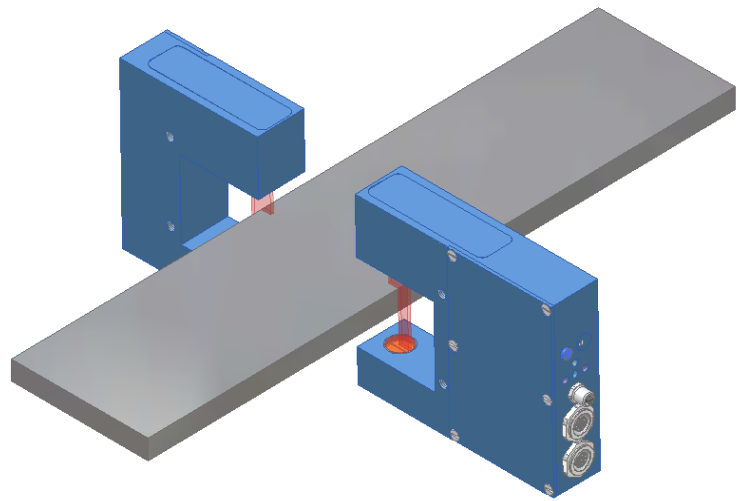

Pic. 1
Measuring of objects of any width in master-slave mode

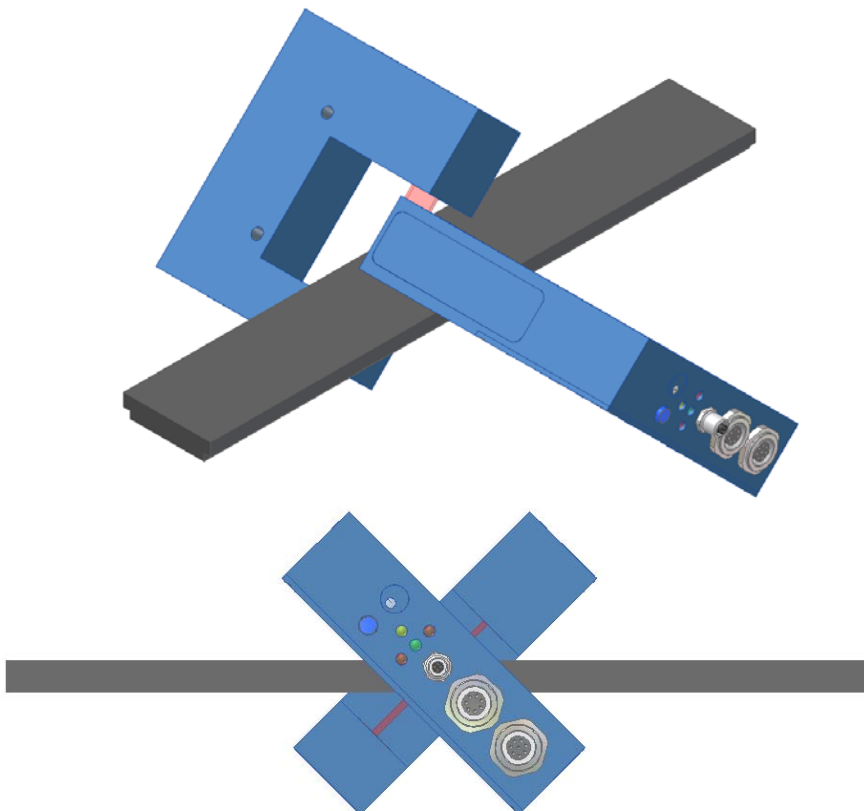

Pic. 2
For measuring objects of small width, the sensors can be arranged at an angle to each other

Application Examples

Foil sheet measuring

The task is to check the position of the foil sheet crosswise to the direction of feed, and the width of the sheet. An analog signal (0V ... +10V) informing about the position of the sheet is provided at the output.

As an option, the covering status of each sensor can be represented separately by means of a second analog signal (0V ... +10V).

Semi-transparent and transparent foils can also be checked by way of a special evaluation method.

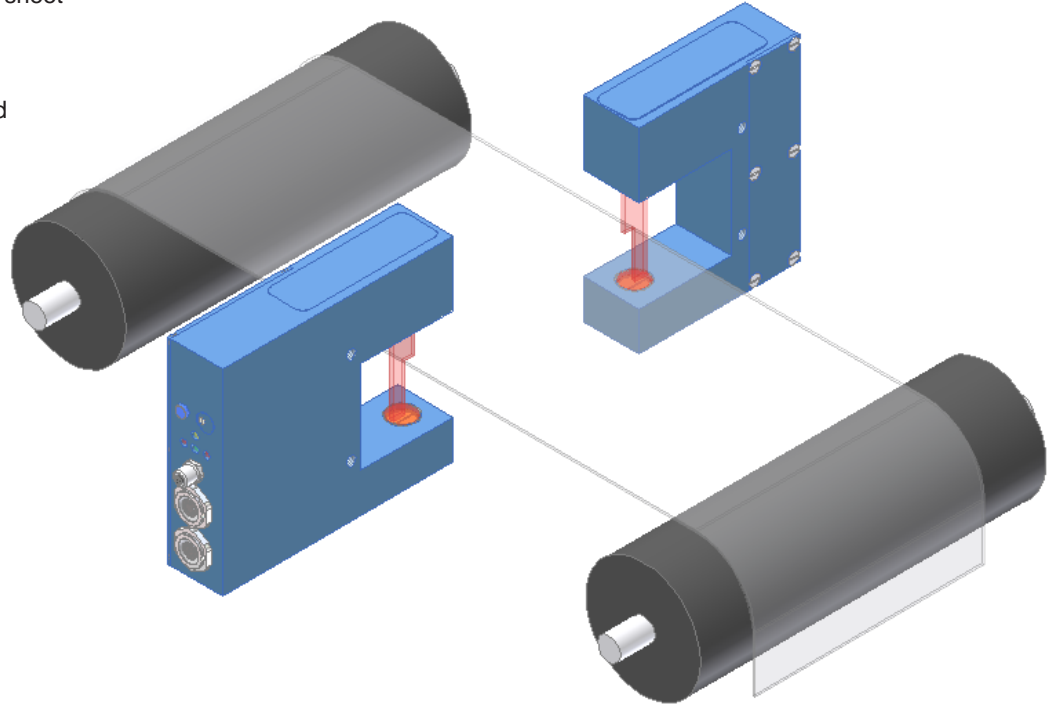

L-LAS-WDC-40/40-8

Thickness measuring of foils with adhesive application

The sensor system is also suitable for measuring the thickness of foils that are guided over a roller. For this purpose, one laser light curtain is directed tangentially onto the roller, whereas the second laser light curtain tangentially aims onto the roller with foil. The difference of these two signals provides information about the thickness of the foil. In an analog way, it is also possible, for example, to measure the thickness of adhesive application on the foil, with laser light barrier 1 measuring the height of the foil, and laser light barrier 2 measuring the height of the foil with applied adhesive.

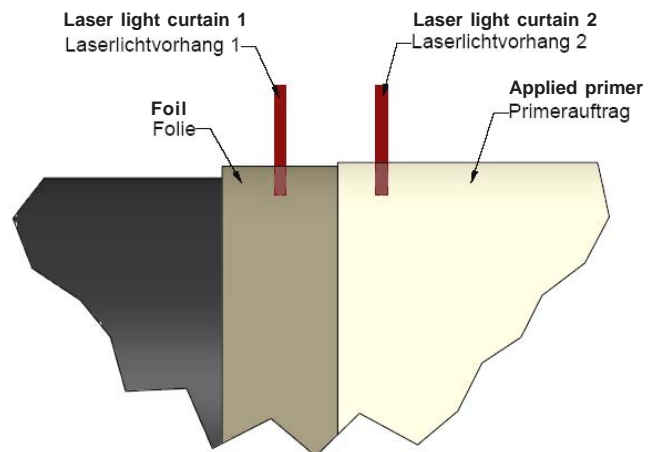
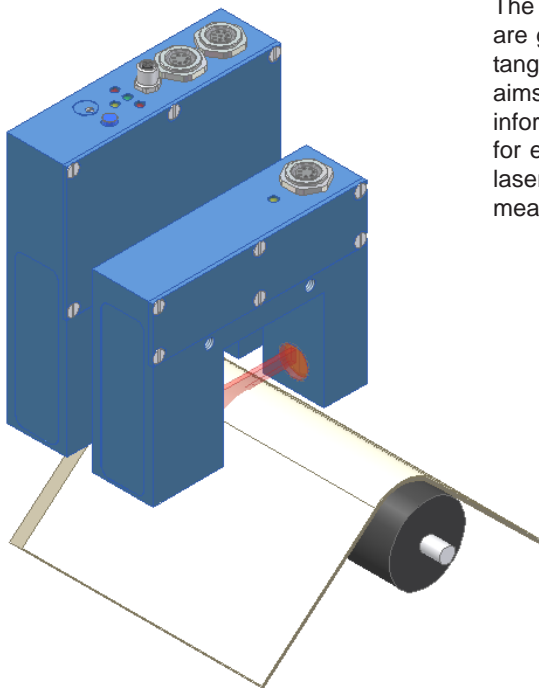



 Application Examples

L-LAS-WDC-40/40-8

Checking the diameter of cables, rods, and needles

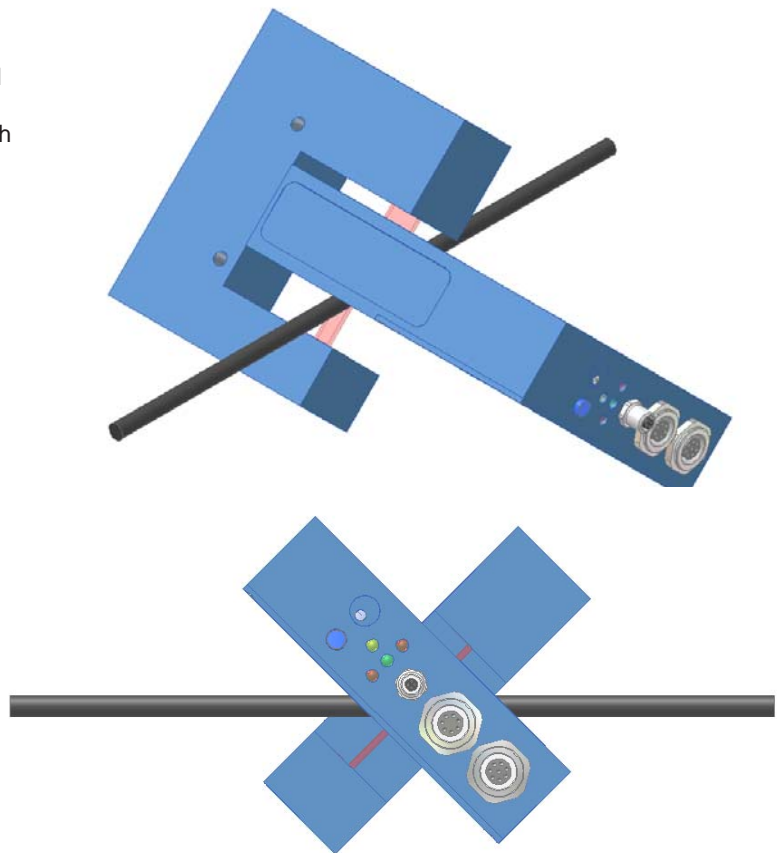
For this measuring task the two laser forks are arranged at an angle of 90° to each other, so that the light curtains of the two sensors form a right angle with respect to each other. When a rotationally symmetric object now enters both light curtains, the diameter of the object is measured under two different perspectives (arranged at 90° to each other). The mean value of the two signals provides information about the diameter of the object.

**Rotation angle / torque measurement**

Two disks (segment disks) that are attached to a shaft are used each for measuring the rotation angle with a laser sensor. The difference of the two rotation angles provides information about the torque acting on the shaft.

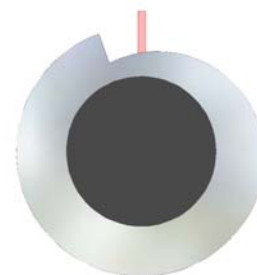
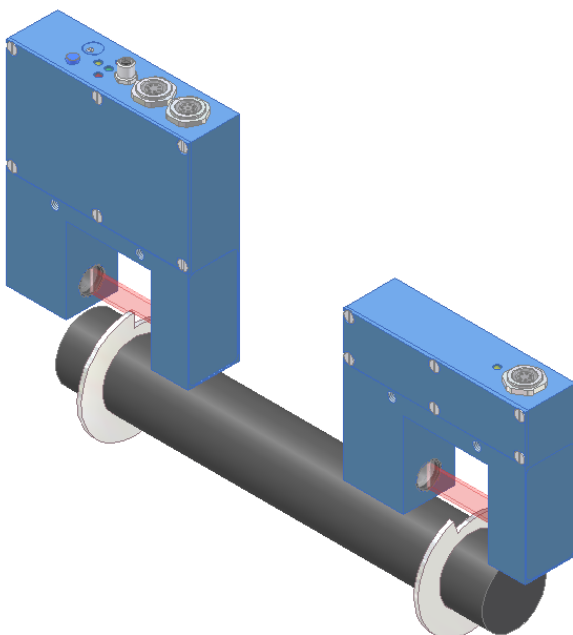



Application Examples

L-LAS-WDC-40/40-8

Checking the diameter of tubes or cylindrical objects

Two laser light barriers are directed tangentially onto the object in such a way that one light curtain passes the object to be measured on the left side, while the second light curtain measures the right side.

