

## INTRODUCTION

Mosaic is a modular, configurable safety controller for protecting machines or plants. Mosaic is capable of monitoring several safety sensors and commands, such as safety light curtains, laser scanners, photocells, mechanical switches, mats, emergency stops, two-hand controls, concentrating management of these in a single, flexible device. Thanks to MCT modules, parts of the Mosaic System can be decentralized in remote cabinets with respect to the master unit M1. Mosaic offers numerous advantages compared with safety solutions based on traditional components, such as relay type safety modules, as it:

- Reduces the number of components and therefore footprint and wiring. Promotes faster electrical cabinet construction.
- Affords the necessary logical configuration using a single, simple programming software, facilitating modifications by machine designers.
- Makes it possible to set up tamper-proof safety systems.
- Simplifies machine maintenance through the MCM memory card, which can be used to transfer the configuration program to a new Mosaic in just a few simple steps.



Mosaic is certified to the highest safety levels established by industrial safety standards: SIL 3, SILCL 3, PL e, Cat. 4.

## SYSTEM DESCRIPTION

Mosaic comprises a master unit M1 configurable via the MSD (Mosaic Safety Designer) graphic interface – provided with each master unit at no extra cost and a maximum of 14 expansion units connectable to M1 via the MSC proprietary bus. The main features can be summarized in the following list:

- can be used with the main safety sensors and commands;
- digital safety inputs, programmable individually or in pairs, with the possibility of monitoring via dedicated output signals;
- wide range of software-configurable safety functions and logical operators;
- possibility of programming filters and delays for each single input and possibility of programming output activation and de-activation delays;
- possibility of independent control of pairs of outputs;
- max. 14 expansion units in addition to the M1 Master, excluding relay modules;
- max. 128 inputs, 16 OSSD pairs, 16 feedback restart e/o interlock inputs and 32 status outputs;
- simple diagnostics via front led signalling and configuration software;
- compact design: single module dimensions 22.5 x 99 x 114.5 mm;
- removable terminal blocks, screw contacts.

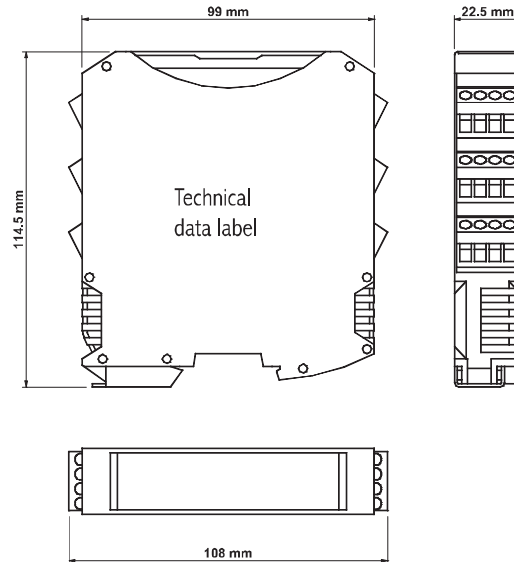

### Safety level: SIL 3 – SILCL 3 – PL e – Cat. 4 – Type 4

- 2006/42/EC “Machinery Directive”
- 2004/108/EC “Electromagnetic Compatibility (EMC)”
- 2006/95/EC “Low Voltage Directive (LVD)”
- CEI EN 61131-2 “Programmable Controllers. Part 2: Equipment requirements and tests”
- EN ISO 13849-1,2 “Safety of machinery: Safety-related parts of control systems. Part 1: General principles for design”. Part 2: Validation”
- EN 954-1 “Safety of machinery – Safety-related parts of control systems - General principles for design”
- IEC/EN 61496-1 “Safety of machinery: Electro-Sensitive Protection Equipment. Part 1: General requirements and tests”
- IEC/EN 62061 “Safety of machinery - Functional safety of safety-related electrical, electronic and programmable electronic control systems”
- IEC 61508-1,2 “Functional safety of electrical, electronic and programmable electronic safety-related systems. Part 1: General requirements” Part 2: Requirements for electrical, electronic and programmable electronic safety-related systems”
- IEC 61508-3: “Functional safety of electrical, electronic and programmable electronic safety-related systems – Part 3: Software requirements”
- IEC 61784-3: “Industrial communication networks - Profiles - Part 3: Functional safety fieldbuses - General rules and profile definitions”
- IEC/TS 62046 Ed. 2 “Safety of machinery - Application of protective equipment to detect the presence of persons”
- UL (C+US) mark for USA and Canada
- AUSA /UL 1998 “Safety Software in Programmable Components”.



Safety level:

**SIL 3**

**SIL 3 – SILCL 3  
PL e – Cat. 4**

**USB connection**

The Mosaic M1 master is equipped with a USB 2.0 serial bus for the connection to a PC on which the MSD (Mosaic Safety Designer) configuration software is held.

**Mosaic Configuration Memory – MCM**

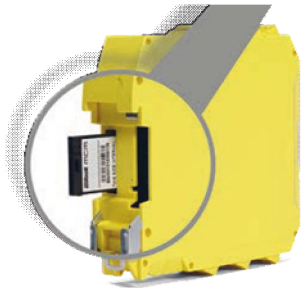

Mosaic MCM is a proprietary removable memory card that can be used to save Mosaic configuration data for subsequent transfer to a new device without using a PC.

The configuration in the MCM overwrites any other configuration present on M1, replacing this with that contained in MCM.

This configuration replacement function can be disabled on M1 via the MSD (Mosaic Safety Designer) configuration software. Overwrite operations are recorded in chronological order in the MOSAIC M1 LOG file.

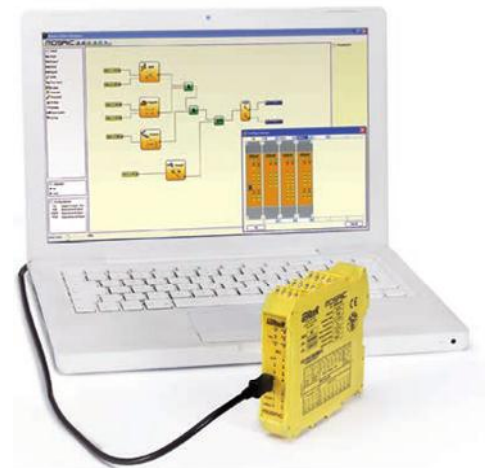

**Mosaic Safety Communication – MSC**



Mosaic MSC permits communication between the various units through a proprietary 5 high-speed safety bus.

The MSC modular connectors can be used to connect the various expansion units to M1. The connectors are physically located on the back of each unit and are housed in the rail guide of the electrical cabinet.

The M1 master unit does not include the MSC connector (not necessary if expansion units are not used). To connect the M1 to the first expansion unit, one MSC connector must be ordered. Each expansion unit is supplied with its own MSC connector.

**Expansion modules for safety speed monitoring**

- **MVO** - Input for 2 PNP/NPN proximity switches
- **MV1** - Input for 1 incremental encoder and 2 PNP/NPN proximity switches
- **MV2** - Input for 2 incremental encoders and 2 PNP/NPN proximity switches

Safety speed monitoring (up to PLe) for: zero speed control, Max. speed, speed range and direction

Up to 4 logically selectable speed thresholds (freely configurable via MSD) for each logical output (axis)

The modules includes two configurable via MSD logical outputs and is therefore able to control up to two independent axis

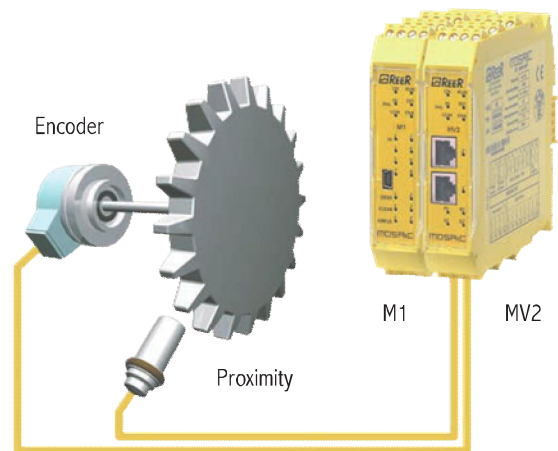

▶ See Safecoder safety encoder on page 179

**BUS modules allowing the connection of remote expansions.**

- **MCT1** - 1 connection interface (1 I/O cable - 1 input or 1 output)\*
- **MCT2** - 2 connections interface (2 I/O cable 1 input and 1 output)

Interface module allowing the connection of remote expansions via the MSC bus.

Up to 50 m for each connection (Total distance up to 250 m).

Ideal solution for the interconnection of the safety functions of more machineries on a single production line.

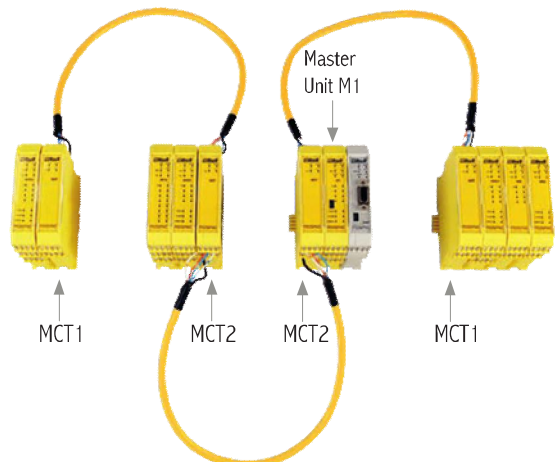

\* End of the network or Start of the network.



## Modules description (main and expansion units)

<p><b>Master module M1</b></p> <p>Main unit, also usable as a stand-alone device, able to control any other expansion units</p> <ul style="list-style-type: none"> <li>8 digital inputs</li> <li>2 inputs for Start/Restart interlock and external device monitoring (EDM)</li> <li>2 OSSD pairs with 400 mA output current</li> <li>4 test outputs for sensor monitoring</li> <li>2 programmable digital signal outputs</li> <li>MCM configuration memory card (optional)</li> <li>LOG file containing the last 5 configuration modifications in chronological order, with date of modification</li> <li>24 connectors in 22.5 mm</li> <li>Possible connection with Reer MSC rear bus for connection with other expansion units</li> <li>Configurable from PC via USB interface using MSD software.</li> </ul>			
<p><b>MOSAIC MI802</b></p> <p>I/O expansion unit.</p> <ul style="list-style-type: none"> <li>8 digital inputs</li> <li>2 inputs for Start/Restart interlock and external device monitoring (EDM)</li> <li>2 OSSD pairs with 400mA output current</li> <li>4 test outputs for sensor monitoring</li> <li>2 programmable digital signal outputs</li> <li>Connectable to M1 via MSC proprietary bus.</li> </ul>		<p><b>MOSAIC MI8 – MI16</b></p> <p>Input expansion unit:</p> <ul style="list-style-type: none"> <li><b>MI8</b> – 8 digital inputs</li> <li><b>MI16</b> – 16 digital inputs</li> <li>4 test outputs for sensor monitoring</li> <li>Connectable to M1 via MSC proprietary bus.</li> </ul>	
<p><b>MOSAIC MI12T8</b></p> <p>Input expansion unit.</p> <ul style="list-style-type: none"> <li>12 digital inputs</li> <li>8 test outputs for sensor monitoring: can control up to four 4-wire safety mats</li> <li>Connectable to M1 via MSC proprietary bus.</li> </ul>		<p><b>MOSAIC M02 – M04</b></p> <p>Output expansion units:</p> <ul style="list-style-type: none"> <li>2/4 inputs for Start/Restart interlock and external device monitoring (EDM)</li> <li><b>M02</b> - 2 OSSD pairs</li> <li><b>M04</b> - 4 OSSD pairs</li> <li>Output current - 400mA</li> <li>2/4 programmable digital signal outputs</li> <li>Connectable to M1 via MSC proprietary bus.</li> </ul>	
<p><b>MOSAIC MR2 – MR4</b></p> <p>Safety relay modules.</p> <ul style="list-style-type: none"> <li><b>MR2</b> - 2 relays – 2 NO + 1 NC connectable to 1 OSSD pair + 1 NC contacts for external device monitoring (EDM)</li> <li><b>MR4</b> - 4 relays – 4 NO + 2 NC connectable to 2 independent OSSD pairs + 2 NC contacts for external device monitoring (EDM)</li> <li>2/4 safety relays with 6A 250 VAC guided contacts</li> </ul> <p>Each NO contact is interrupted twice by 2 safety relays. Mosaic MR2 and MR4 are passive units that can also be used separately from the Mosaic system.</p> <p><b>The MR expansion units do not require MSC as they are wired directly to the selected OSSD.</b></p>		<p><b>MOSAIC MOR4 - MOR4 S8</b> <small>NEW PRODUCT</small></p> <p>Safety relay expansion units with configurable outputs.</p> <ul style="list-style-type: none"> <li>4 internal safety relays with guided contacts 6A 250 VAC</li> <li>4 inputs for Start/Restart interlock and external device monitoring (EDM)</li> <li>The relay outputs can be configured via the MSD software as: <ul style="list-style-type: none"> <li>4 single-channel outputs (safety category 1 or 2) or</li> <li>2 dual-channels outputs (safety category 4)</li> </ul> </li> <li>Model <b>MOR4 S8</b> also has 8 programmable digital signal outputs</li> <li>Connectable to M1 through MSC Bus.</li> </ul>	

**MOSAIC MB**

Expansion unit for connection to the most common industrial Fieldbus systems for diagnostics and data communication.

- MBP - Profibus DP
- MBD - DeviceNET
- MBC - CANopen
- MBEI - Ethernet IP
- MBEC - EtherCAT
- MBEP - PROFINET
- MBU - Universal Serial Bus.

Connectable to M1 via MSC proprietary bus.



**MOSAIC MCT** NEW PRODUCT

Interface module allowing the connection of remote expansions via the MSC bus.

- **MCT1** - 1 connection interface (1 I/O cable)\*
- **MCT2** - 2 connections interface (2 I/O cable).

Available serial interface shielded cables: MC25 - 25 m; MC50 - 50 m; MC100 - 100 m

We recommend the use of Reer's cables for a correct operation of the system.



**MOSAIC MV** NEW PRODUCT

Expansion modules for safety speed monitoring

- **MV0** - Input for 2 PNP/NPN proximity switches
- **MV1** - Input for 1 incremental encoders and 2 PNP/NPN proximity switches
  - MV1T (1 TTL encoder + 1 or 2 proximity switches)
  - MV1H (1 HTL encoder + 1 or 2 proximity switches)
  - MV1S (1 SIN/COS encoder + 1 or 2 proximity switches)
- **MV2** - Input for 2 incremental encoders and 2 PNP/NPN proximity switches
  - MV2T (1 or 2 TTL encoders + 1 or 2 proximity switches)
  - MV2H (1 or 2 HTL encoders + 1 or 2 proximity switches)
  - MV2S (1 or 2 SIN/COS encoders + 1 or 2 proximity switches)
- RJ-45 (1 for MV1, 2 for MV2) connectors for encoders and terminal blocks for proximity switches
- Max input frequency for encoders: up to 500 KHz (300 KHz for HTL encoder)
- Max input frequency for proximity switches: up to 5 KHz.



**ORDERING INFORMATION**

A CD-ROM containing the MSD configuration software multi-language instruction manual and CE declaration of conformity is supplied with each M1 unit.

The M1 master unit does not include the MSC connector. To connect the M1 to the first expansion unit one, MSC connector must be ordered. (Not necessary if expansion units are not used).

Each expansion unit is supplied with its own MSC connector.

The MR2 and MR4 safety relay modules are only connected to the other units via hard-wiring and therefore do not require the MSC connector.

**ACCESSORIES ORDERING CODE**

Model	Ordering code	Description
MCM	1100060	Mosaic Configuration Memory – Memory Card
MSC	1100061	Mosaic Safety Communication – Connector
CSU	1100062	USB A cable – mini B, length 1,8 m
MC25	1100063	MCT serial cable for MSC bus transfer 25 m
MC50	1100064	MCT serial cable for MSC bus transfer 50 m
MC100	1100065	MCT serial cable for MSC bus transfer 100 m

**TECHNICAL FEATURES & ORDERING CODES**

Module	M1	MI802	MI8 MI16	MI12T8	MO2 MO4	MR2 MR4	MCT1 MCT2	MOR4 MOR4 S8	MV	MBx
<b>Ordering code</b>	1100000	1100010	1100020 1100021	1100022	1100030 1100031	1100040 1100041	1100058 1100057	1100042 1100043	see table below	see table below
<b>Description</b>	Master unit	I/O Expansion unit	Input Expansion units	Input Expansion unit	Output Expansion units	Guided contact relay output Expansion units	Bus Transfer Expansion units	Safety relay configurable output Expansion units	Safety speed control Expansion units	Expansion units for bus
<b>USB</b>	yes	-	-	-	-	-	-	-	-	yes
<b>Housing for MCM</b>	yes	-	-	-	-	-	-	-	-	-
<b>Connection with MSC bus</b>	yes	yes	yes	yes	yes	-	yes	yes	yes	yes
<b>MSC connector provided</b>	no	yes	yes	yes	yes	-	yes	yes	yes	yes
<b>Safety Level</b>	SIL 3 – SILCL 3 according to IEC 61508 - IEC 62061 / PL e – Cat. 4 according to ISO 13849-1									-
<b>Safety inputs</b>	8	8	8 or 16	12	-	-	-	-	2 or 4	-
<b>Safety outputs (OSSD)</b>	2 pairs PNP 400 mA	2 pairs PNP 400 mA	-	-	2 or 4 pairs PNP-400 mA	1 or 2 pairs	-	-	-	-
<b>Programmable signal outputs status</b>	2 PNP 100 mA	2 PNP 100 mA	-	-	2 or 4 PNP 100 mA	-	-	<b>MOR4 S8</b> 8 PNP 100 mA	-	-
<b>Test outputs</b>	4	4	4	8	-	-	-	-	-	-
<b>Safety relay outputs</b>	-	-	-	-	-	2 NO + 1 NC 4 NO + 2 NC 6 A 250 VAC	-	4 NO single 6 A 250 VAC or 2 NO pairs 6 A 250 VAC	-	-
<b>Start/Restart inputs and External Device Monitoring (EDM)</b>	2	2	-	-	2 or 4	-	-	4	-	-
<b>Led signalling</b>	Input/output status and fault diagnostics					Output status			Input status and fault diag.	Fault diag.
<b>Power supply (VDC)</b>	24 ± 20%									
<b>Electrical connections</b>	Removable terminal blocks, screw contacts									
<b>Operating temperature</b>	-10 ... 55 °C									
<b>Storage temperature</b>	- 20 ... 85 °C									
<b>Protection rating</b>	IP 20 for housing / IP 2X for terminal block									
<b>Fastening</b>	DIN rail fastening according to EN 50022-35 standard									
<b>Dimension (h x w x d)</b>	99 x 22,5 x 114									

**MBx ordering codes**
**MV ordering codes**

Model	Description	Ordering code	Model	Description	Ordering code
<b>MBP</b>	Expansion unit Profibus DP	1100050	<b>MV1T</b>	1 TTL encoder expansion unit	1100070
<b>MBD</b>	Expansion unit DeviceNet	1100051	<b>MV1H</b>	1 HTL encoder expansion unit	1100071
<b>MBC</b>	Expansion unit CANopen	1100052	<b>MV1S</b>	1 Sin/Cos encoder expansion unit	1100072
<b>MBEC</b>	Expansion unit EtherCAT	1100053	<b>MV2T</b>	2 TTL encoder expansion unit	1100073
<b>MBEI</b>	Expansion unit Ethernet IP	1100054	<b>MV2H</b>	2 HTL encoder expansion unit	1100074
<b>MBEP</b>	Expansion unit PROFINET	1100055	<b>MV2S</b>	2 Sin/Cos encoder expansion unit	1100076
<b>MBU</b>	Expansion unit Universal Serial Bus	1100056	<b>MV0</b>	Only proximity switches expansion unit	1100077

**MOSAIC SAFETY DESIGNER - MSD**

MSD (Mosaic Safety Designer) is the free of charge, easy-to-use and intuitive MOSAIC configuration software. MSD main features:

- “Drag&Drop” configuration of all safety functions
- Functional validation of design
- Configuration of parameters of function blocks
- Real-time monitoring of I/O status
- Single or bi-directional, 2 or 4 sensors muting function blocks
- 2-level passwords management for the prevention of unauthorised accesses and therefore of incidental modifications or tampering of the system configuration

**MAIN FUNCTIONAL BLOCKS**

The MSD interface allows configuration of the system functional blocks parameter.

**Safety input object**

For example: ESPE - opto-electronic safety barrier or safety laser scanner.

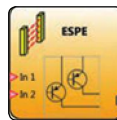

**Safety speed monitoring input object (new)**

For example: Safety speed monitoring for zero speed, Max. speed, speed range and direction

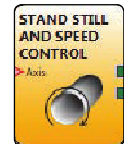

**Non safety input object**

For example: non-safety sensor and non-safety button or switch



**Output object**

For example: OSSD (safety outputs), STATUS (programmable signal output)

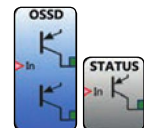

**OPERATORS**

The MSD interface allows configuration of the system operators parameter. The available object are:

**MUTING OPERATORS**

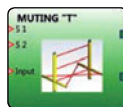

The Muting function permits the automatic, temporary and safe disabling of the ESPE at certain stages in the machine cycle. There are two main types of applications:

- To permit access to the hazardous area by personnel during the non-hazardous part of the machine cycle.
- To permit the passage of materials and prevent access by personnel. For example: palletizer applications.

**GUARD LOCK OPERATOR (new)**



Allows you to control a safety lock verifying the consistency between the lock/unlock command and E-GATE and feedback status.

**NETWORK OPERATOR (new)**

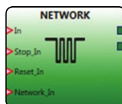

The Network operator is used to distribute Stop and Restart command via a simple local network in form of loop.

It is possible to Stop and Restart all machines (Mosaic) of the loop from any position.

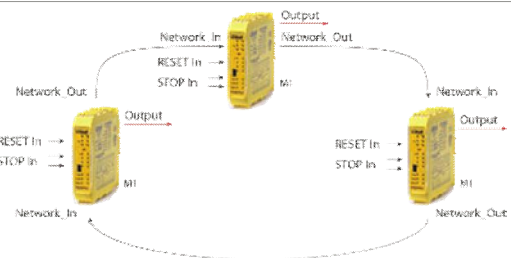

**SERIAL OUTPUT (new)**

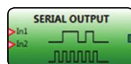

Returns as output the status of max 8 inputs through a simulated serial line.

**MEMORY OPERATORS**



Allow the user to store signals coming from the objects forming the application. For example: D FLIP FLOP, MANUAL USER RESTART, MONITORED USER RESTART.

**TIMER OPERATORS**



Timer type operators permit generation of a signal for the set time. For example: DELAY, MONOSTABLE; CLOCKING

**COUNTER OPERATOR**



Counter type operator permits generation of a signal on reaching the set number.

**LOGICAL OPERATORS**



For example: AND, OR, NAND, NOR, XOR, NOT e multiplexer.

## APPLICATION EXAMPLE 1

### Safety management of a palletizing system with two robotic cells

The system comprises a conveyor that transports boxes to two robotic palletization cells.

The machine is completely protected by a fence with three access gates (one for each robotic cell and one for the conveyor area) equipped with a safety switch. When the gate of the robotic cell is opened, the corresponding robot stops. When the conveyor area gate is opened the entire plant stops.

The completed pallets are collected by a forklift truck through the access gate which is protected by a safety light curtain. The access of the forklift truck for collecting the pallet, when the robot is stopped in the rest position, by reason of the safety light curtains, prevents the robot to start. In all other phases of processing, occupation of each light curtain causes the related robot to stop.

The related manual restart control is located close to each light curtain.

The system is equipped with four emergency push buttons (E-STOP).

Total safety devices: 2 safety light curtains - 2 restart buttons for the safety light curtains - 3 safety gate switches - 4 emergency push buttons.

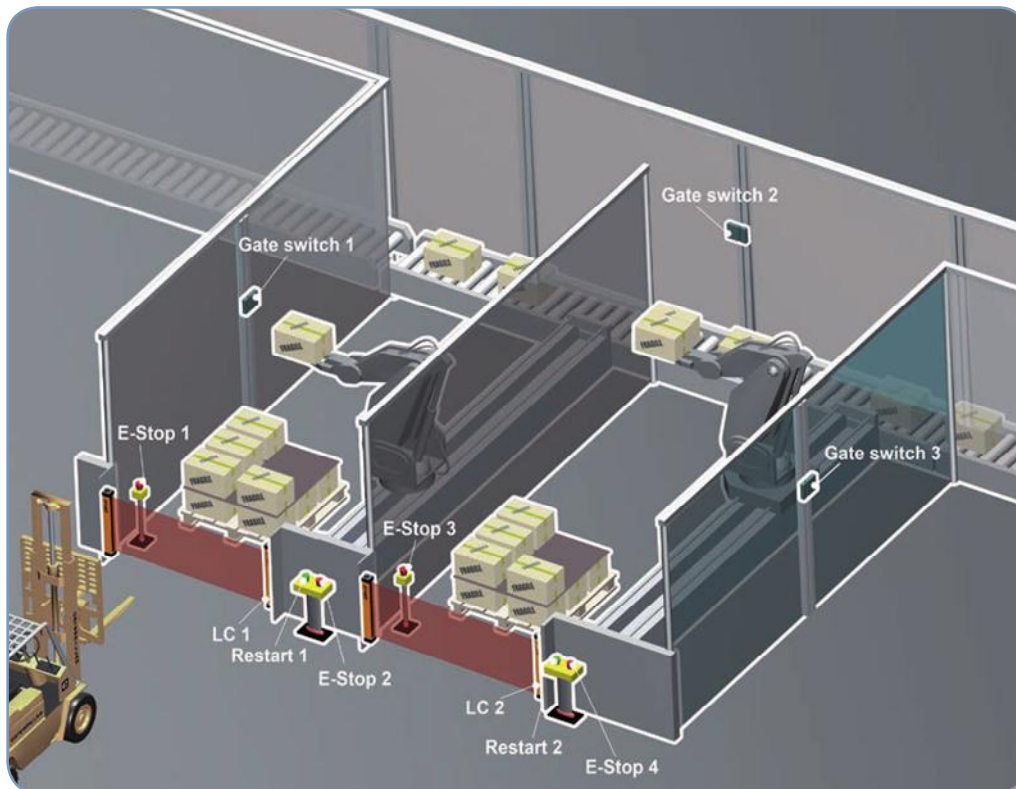

Using conventional components – safety relay modules – to build up the safety circuit, it would be necessary to use at least six safety modules, wired to each other in order to perform the required functions: 2 safety relays for the light curtains - 3 safety relays for the gate switches - 1 safety relay for the emergency stop.



### APPLICATION EXAMPLE 1 - SOLUTION WITH MOSAIC

Using Mosaic to build up the safety circuit, it is sufficient to use:

- 1 main unit M1
- 1 expansion unit MI802

which provide a total of:

- 16 inputs
- 4 OSSD pairs
- 8 test outputs
- 4 signal outputs.

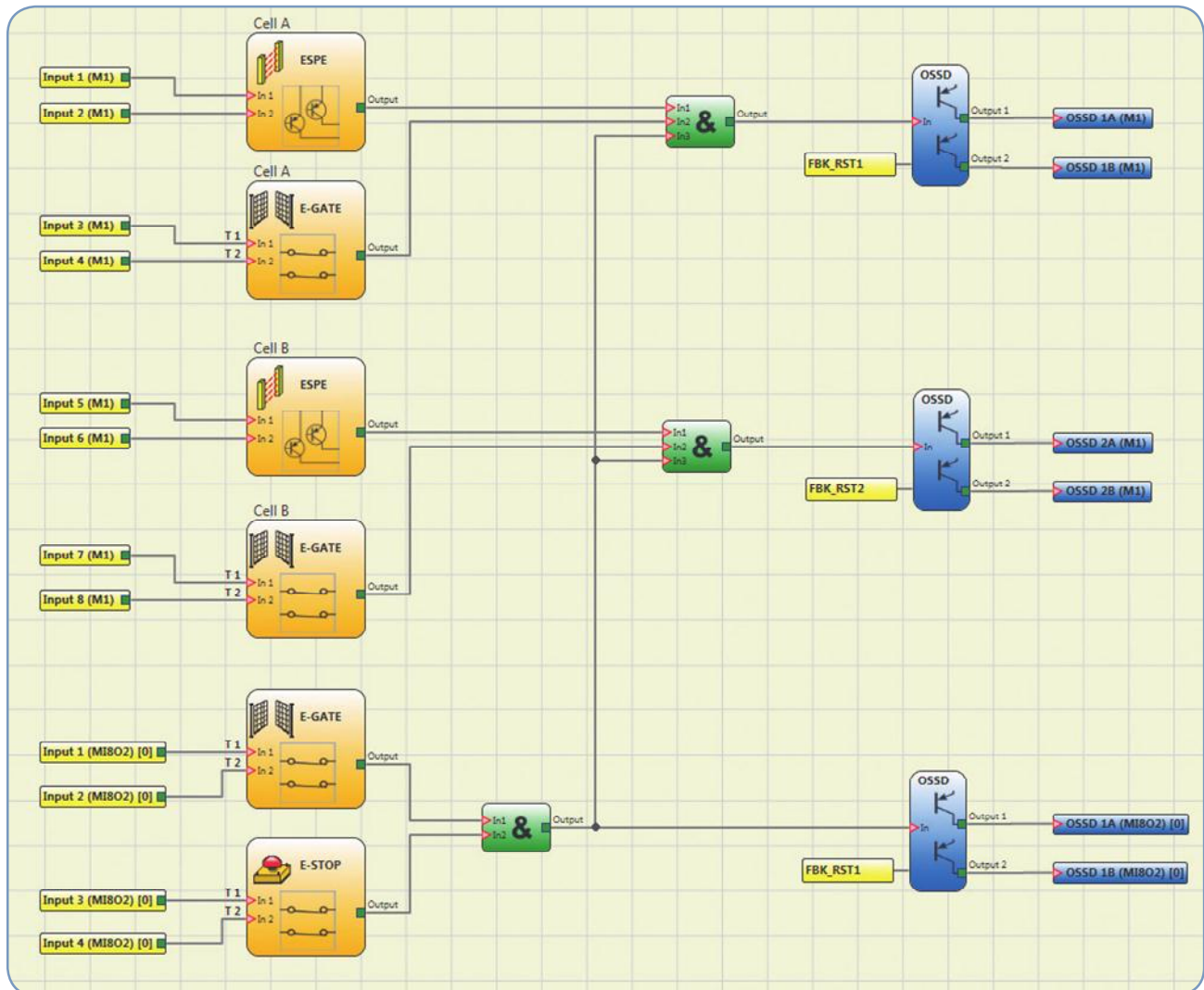

**Note:** The Reset buttons are not displayed on the diagram because they are directly connected to the feedback of the OSSD safety outputs (inputs FBK\_RST1, FBK\_RST2).  
The 4 E-STOP are connected in series and are represented in the diagram with a single input block.

## APPLICATION EXAMPLE 2

### Safety management of a machining centre with alternate load / unload

The operator is required to load and unload the workpiece.

The machine is protected by two horizontal safety light curtains. In this case, each light curtain must be equipped with the muting function so as to permit access to the hazardous area by personnel during the non-hazardous part of the machine cycle.

Depending on the position of the tool, which is the hazardous element, one of the two light curtains (the one facing the tool working area) is active, while the other is muted so that the operator can load/unload the workpiece. The Muting condition of the two safety light curtains will then be inverted when the tool is required to operate on the opposite side of the machine.

The machine is completely protected by a fence with an access gate equipped with a safety switch. When the gate is opened, the machine stops.

The related manual restart control is located close to each safety light curtain. The system is equipped with three emergency push buttons which, if activated, stop the machine.

Total safety components: 2 safety light curtains - 2 restart buttons for the safety light curtains - 1 safety gate switch - 3 emergency push buttons.

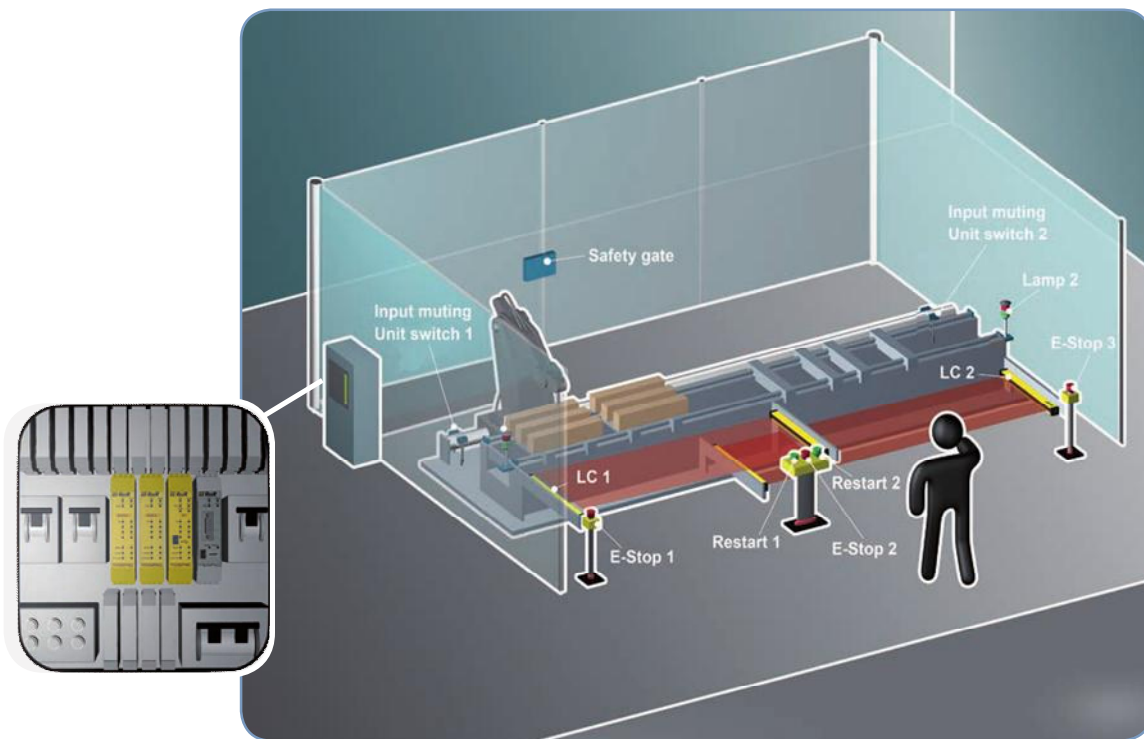

Using conventional components – safety relay modules – to build up the safety circuit, four safety modules would be necessary: 2 safety modules for the safety light curtains with muting function - 1 safety module for the gate switch - 1 safety module for the emergency stop.

## APPLICATION EXAMPLE 2 - SOLUTION WITH MOSAIC

Using Mosaic to build up the safety circuit, it is sufficient to use:

- 1 main unit M1
- 1 expansion unit M18

Which provide a total of:

- 16 inputs
- 2 OSSD pairs
- 8 test outputs
- 2 signal outputs.

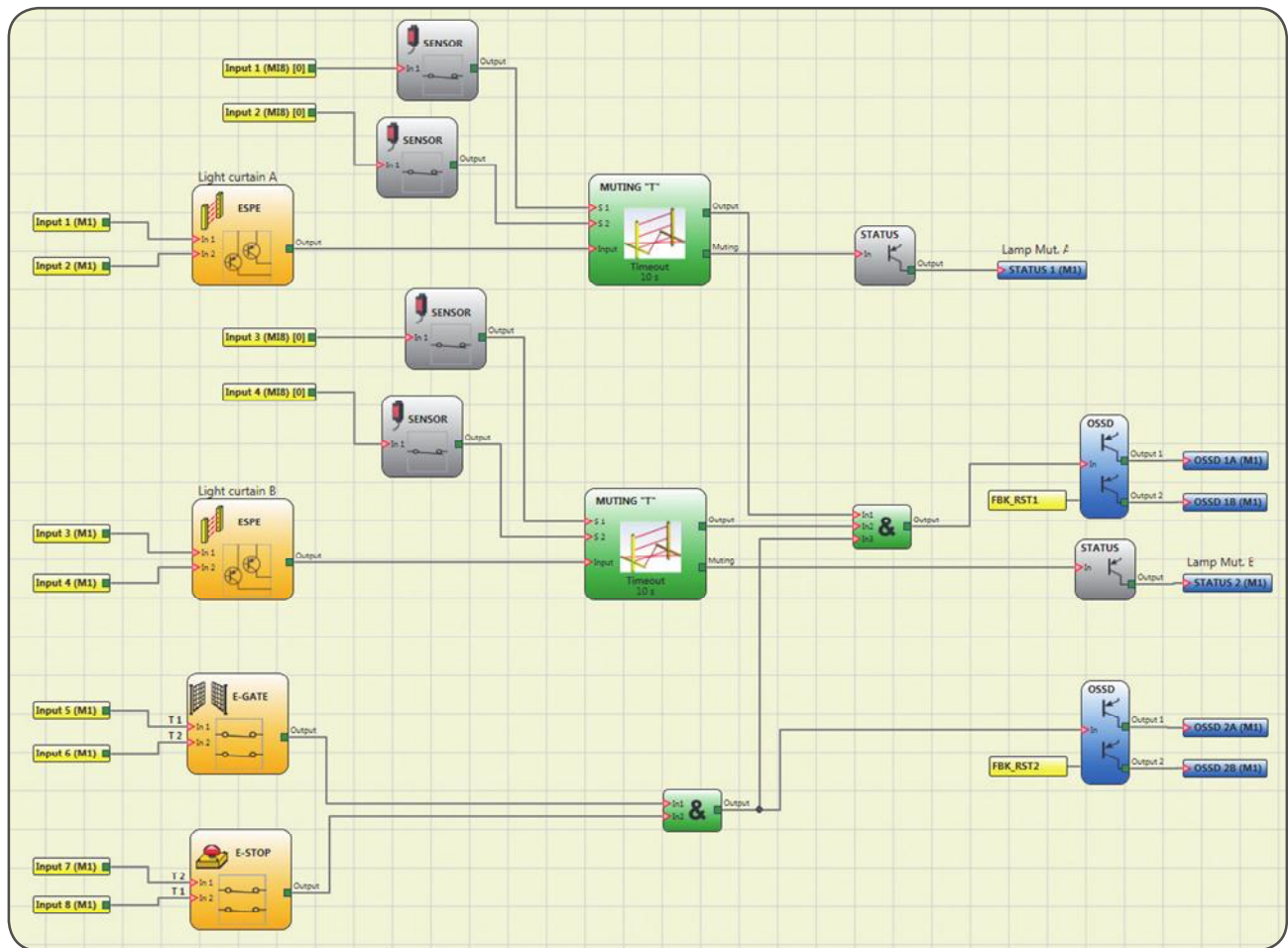

**Note:** The Reset buttons are not displayed on the diagram because they are directly connected to the feedback of the OSSD safety outputs (inputs FBK\_RST1, FBK\_RST2).

The 3 E-STOP are connected in series and are represented in the diagram with a single input block.

The diagram also shows the status of 2 outputs used to drive the indication lights of the active muting.

### APPLICATION EXAMPLE 3

#### Speed monitoring for a hazardous tool

In this example the positioning of the workpiece is allowed only when the tool is completely stopped.

As long as the tool is working at the normal speed the GUARD LOCK is locked and the access to the hazardous area is not allowed.

Access to the hazardous area is allowed either when the working cycle is over or when the operator switches the MOD SEL to "Access Request".

In the second case, the GUARD LOCK is unlocked with a 4 seconds delay, that is the time needed to permit to the machine to completely stop the tool (time measured during the risk assessment). At this point the operator can safely access the hazardous area.

If the tool has to be kept moving for maintenance reasons as the operator is inside the hazardous area this is possible through the Grip Switch. The speed monitoring device detects whether the speed of the tool is under a defined threshold set through the MSD. If the threshold is exceeded or the Grip Switch is released the machine is immediately stopped.

Furthermore, during the working cycle the same speed monitoring device can detect when the speed of the tool is over a defined threshold and immediately stop the machine to avoid damages to the nearby operators and to the tool itself.

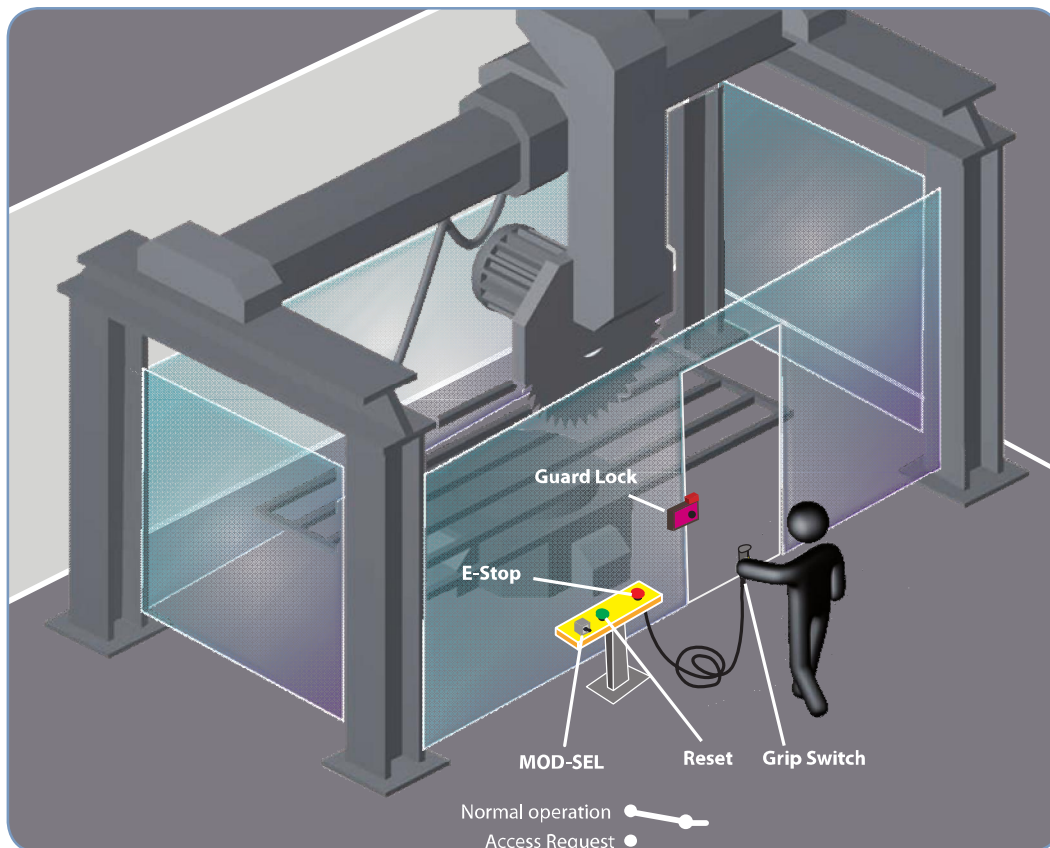



Using Mosaic to build up the safety circuit, it is sufficient to use:

- 1 main unit M1
- 1 expansion unit M18
- 1 expansion unit MV1 for safety speed monitoring;

which provide a total of:

- 18 available inputs (24 usable inputs)
- 2 OSSD pairs
- 2 signal outputs.

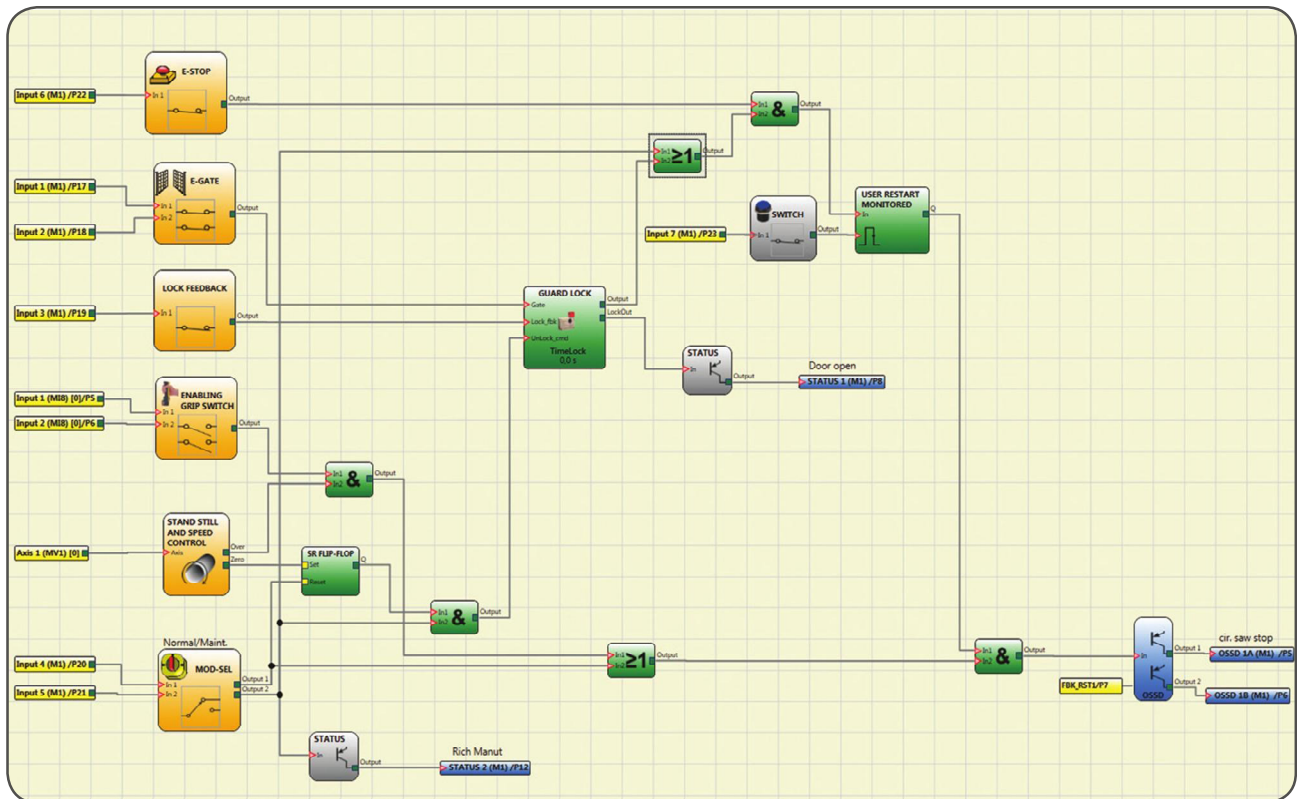

**Comments:**

Using MOSAIC, all the safety logic circuitry is implemented using the graphic interface and not by hard-wiring the outputs of the relay modules to each other. Correct functioning of the logic circuitry is checked during the design phase by the VALIDATION function and can be tested with the MONITOR function during installation.

During the design phase, safety functions can be easily added or removed, for example adding other sensors or zones. Start up tests can be inserted in order to detect any attempt of by-passing the safety system, which is always a possibility with traditional relay modules.

The two-level password provides protection against unauthorised modification of system configuration.

**Conclusions:**

The three examples have been intentionally simplified. In reality, it is often necessary to implement a great number of functions such as delays, filters or more complex safety logics that combine signals from several sources.

This would entail the use of numerous relay modules, thereby further complicating implementation of the logic circuitry, wiring and final cost.

MOSAIC provides designers with all the logical safety functions and these can be immediately combined using only the MSD graphic interface.

