

How to read the safety light curtain codes of the EOS series

EOS 2 60 4 X

Functions of the safety light curtain:

- A - Automatic Start/Restart
- X - Built-in control functions - EDM and selectable manual/automatic Start/Restart
- H - High range
- M - Master
- S - Slave
- S2 - Slave 2

Resolution:

1 - 14 mm	4 - 40 mm
2 - 20 mm	5 - 50 mm
3 - 30 mm	9 - 90 mm

Protected heights:

15 - 160 mm	75 - 760 mm	135 - 1360 mm
25 - 260 mm	85 - 860 mm	145 - 1460 mm
30 - 310 mm	90 - 910 mm	150 - 1510 mm
45 - 460 mm	105 - 1060 mm	165 - 1660 mm
55 - 560 mm	115 - 1160 mm	180 - 1810 mm
60 - 610 mm	120 - 1210 mm	

Safety level:

2 or 4

Family:

EOS

EOS 4 2B X

Functions of the safety light curtain:

- A - Automatic Start/Restart
- X - Built-in control functions - EDM and selectable manual/automatic Start/Restart
- H - High range
- M - Master
- S - Slave
- S2 - Slave 2

Number of beams:

2B - 2 beams
3B - 3 beams
4B - 4 beams

Safety level:

2 or 4

Family:

EOS

EOS4



EOS4

EOS4 is a compact Type 4 light curtain with competitive performance and innovative features.

Its features include:

- Minimal cross section: 28 x 30 mm.
- No blind area on one side: the position of first beam ensures that the sensitive area extends to end of the light curtain.
- Minimal blind area on connector side.
- The solution with two L-mounted light curtains, e.g. Master-Slave, maintains 40 mm resolution in corner (models with resolution up to 40 mm).
- Easy connection and installation thanks to the M12 connectors and the use of unshielded cables up to 100 m.
- Integrated safety functions, including self-monitoring of static outputs, control of external contactors (EDM) and automatic/manual selectable Restart.
- Exceptional mechanical and electrical robustness are the result of extensive experience gained hands-on with all kinds of applications.
- Operating temperature range: -10 ... 55 °C.
- Protection rate: IP 65 and IP 67 at the same time
- High resistance to infiltration by dust and liquids in a highly compact light curtain.
- Models Master/Slave for cascade connection of two or three light curtains.
- 2 safety PNP static outputs.

Special versions with IP 69K watertight enclosure (WTF and WTHF), also suitable for Food & Beverage industry, available

► [see page 194.](#)

Special models in conformity with the "ATEX Directive" 94/9/CE - Dust zone 22 - Gas Zone 2 available on request

EOS4 light curtains may be connected to the dedicated safety interfaces series AD SR, or directly to contactors actuated and controlled by the light curtain, or to MOSAIC or to suitable commercial safety modules or safety PLCs.

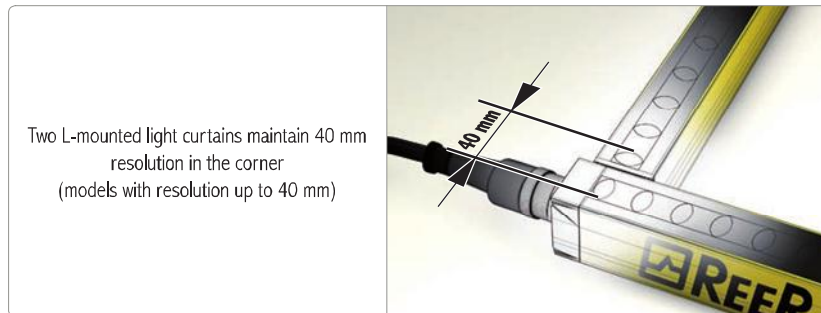

Type 4 – SIL 3 – SILCL 3 – PL e – Cat. 4



THE EOS4 RANGE

EOS4 A	EOS4 AH	EOS4 X	EOS4 XH	EOS4 XS - XM - XS2
Max range 12 m (6 m for 14 mm resolution)	Max range 20 m	Max range 12 m (6 m for 14 mm resolution)	Max range 20 m	Max range 12 m (6 m for 14 mm resolution)
Automatic Start/Restart		Integrated, selectable manual or automatic Start/Restart		Master and Slave models for series connection of 2 or 3 light curtains regardless of height or resolution
The ideal light curtain for straightforward interfacing with safety modules (i.e. ADSR1) or safety PLCs (i.e. MOSAIC)		An effective light curtain for directly controlling and monitoring machine circuits with no need of external safety modules		Master and Slave models permit series connection of up to 3 light curtains and combined detection of hand and presence of a person or of more sides of the machine
External relay monitoring (EDM) through external AD SR1, MOSAIC or safety PLC interface		Feedback input for external relay monitoring (EDM)		
Electrical connections: M12 5-pole connectors		Electrical connections: M12 5-pole connector for emitter M12 8-pole for receiver		
Protected height range 160 to 1810 mm				
Types of detection: Resolution 14 mm for finger detection Resolution 20, 30, 40 mm for hand detection Resolution 50, 90 mm for detection of the body in a dangerous area 2, 3, 4 beams for detection of the body in access control				
2 safety static outputs PNP with auto-test protected against short circuits and overloads				

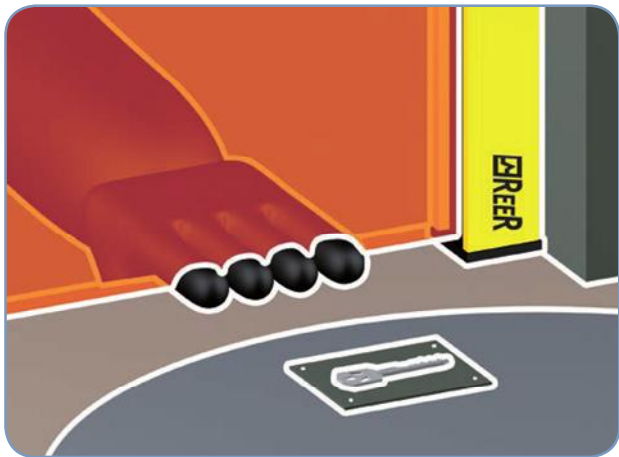

The protected area extends until the light curtain end maintaining the resolution



The resolution is maintained (up to 40 mm) in the junction between the 2 protected areas

EOS4 A / AH

WITH AUTOMATIC START/RESTART

MAIN FEATURES

Automatic Start/Restart.
 Max. range: up to 6 m for 14 mm resolution; up to 20 m for other models.
 Two safety PNP static outputs, auto-controlled.
 All connections and configurations through M12 5-pole connectors.
 Unshielded cables up to 100 meter long.
 Start/Restart interlock and EDM through external AD SR1 interface.
 Muting function through external AD SRM interface.

TECHNICAL FEATURES

Safety level	Type 4 according to IEC/TS 61496-2 SIL 3 – SILCL 3 according to IEC 61508 - IEC 62061 PL e – Cat. 4 according to ISO 13849-1
Protected heights (mm)	160 ... 1810
Resolutions (mm)	14, 20, 30, 40, 50, 90
Numbers of beams for body detection in access control	2, 3, 4
Max. range (m)	selectable 3 or 6 for 14 mm resolution; selectable 4 or 12 for standard models; selectable 10 or 20 for H models with: 20, 30, 40, 50, 90 mm resolution and 2, 3, 4 beams:
Response time (ms)	2,5 ... 20
Safety outputs	2 PNP - 400 mA at 24 VDC with short-circuit, overload, polarity reversal protection
Signalling	LEDs for light curtain's status and diagnostic
Start/Restart	automatic
Power supply (VDC)	24 ± 20%
Electrical connections	M12 5-pole
Max. cable length (m)	100
Operating temperature (°C)	-10 ... 55
Protection rating	IP 65 and IP 67
Fastening modes	back slot or to the top and lower end by rotating brackets SFB E180 (optional)
Cross section (mm)	28 x 30



Emitter - 5 poles

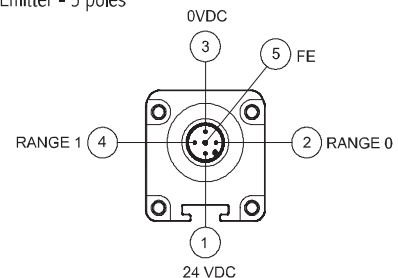

Receiver - 5 poles

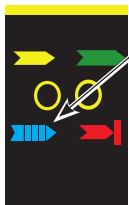
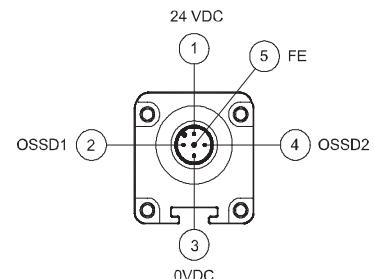

On the receivers of 14 mm resolution and H models a blue LED turns ON when the received beam signal intensity is weak.

During the alignment operations, checking the presence of the blue led weak signal is helpful. Upon completion of alignment and during normal operation, this LED must be off.

Safety level:

TYPE 4

SIL 3 – SILCL 3
PL e – Cat. 4



A Models with 14 mm resolution - Max. range: selectable 3 or 6 m



Resolution 14 mm	EOS4 151 A	EOS4 301 A	EOS4 451 A	EOS4 601 A	EOS4 751 A	EOS4 901 A	EOS4 1051 A	EOS4 1201 A	EOS4 1351 A	EOS4 1501 A	EOS4 1651 A	EOS4 1801 A
Ordering codes	1310000	1310001	1310002	1310003	1310004	1310005	1310006	1310007	1310008	1310009	1310070	1310071
Protected height (mm)	160	310	460	610	760	910	1060	1210	1360	1510	1660	1810
Num. of beams	15	30	45	60	75	90	105	120	135	150	165	180
Overall height (mm)	213	363	513	663	813	963	1113	1263	1413	1563	1713	1863

A Models - Max. range: selectable 4 or 12 m AH Models - Max. range: selectable 10 or 20 m



Resolution 20 mm	EOS4 152AH	EOS4 302AH	EOS4 452AH	EOS4 602AH	EOS4 752AH	EOS4 902AH	EOS4 1052AH	EOS4 1202AH	EOS4 1352AH	EOS4 1502AH	EOS4 1652AH	EOS4 1802AH
Ordering codes	1310150	1310151	1310152	1310153	1310154	1310155	1310156	1310157	1310158	1310159	1310180	1310181
Protected height (mm)	160	310	460	610	760	910	1060	1210	1360	1510	1660	1810
Num. of beams	15	30	45	60	75	90	105	120	135	150	165	180
Overall height (mm)	213	363	513	663	813	963	1113	1263	1413	1563	1713	1863



Resolution 30 mm	EOS4 153 A	EOS4 253 A	EOS4 303 A	EOS4 453 A	EOS4 603 A	EOS4 753 A	EOS4 903 A	EOS4 1053 A	EOS4 1203 A	EOS4 1353 A	EOS4 1503 A	EOS4 1653 A	EOS4 1803 A
Ordering codes	1310200	1311205	1310201	1310202	1310203	1310204	1310205	1310206	1310207	1310208	1310209	1310270	1310271
Resolution 30 mm	EOS4 153AH	-	EOS4 303AH	EOS4 453AH	EOS4 603AH	EOS4 753AH	EOS4 903AH	EOS4 1053AH	EOS4 1203AH	EOS4 1353AH	EOS4 1503AH	EOS4 1653AH	EOS4 1803AH
Ordering codes	1310250	-	1310251	1310252	1310253	1310254	1310255	1310256	1310257	1310258	1310259	1310280	1310281
Protected height (mm)	160	260	310	460	610	760	910	1060	1210	1360	1510	1660	1810
Num. of beams	8	13	16	23	31	38	46	53	61	68	76	83	91
Overall height (mm)	213	313	363	513	663	813	963	1113	1263	1413	1563	1713	1863



Resolution 40 mm	EOS4 154 A	EOS4 254 A	EOS4 304 A	EOS4 454 A	EOS4 604 A	EOS4 754 A	EOS4 904 A	EOS4 1054 A	EOS4 1204 A	EOS4 1354 A	EOS4 1504 A	EOS4 1654 A	EOS4 1804 A
Ordering codes	1310300	1311202	1310301	1310302	1310303	1310304	1310305	1310306	1310307	1310308	1310309	1310370	1310371
Resolution 40 mm	EOS4 154AH	-	EOS 304AH	EOS4 454AH	EOS4 604AH	EOS4 754AH	EOS4 904AH	EOS4 1054AH	EOS4 1204AH	EOS4 1354AH	EOS4 1504AH	EOS4 1654AH	EOS4 1804AH
Ordering codes	1310350	-	1310351	1310352	1310353	1310354	1310355	1310356	1310357	1310358	1310359	1310380	1310381
Protected height (mm)	160	260	310	460	610	760	910	1060	1210	1360	1510	1660	1810
Num. of beams	6	9	11	16	21	26	31	36	41	46	51	56	61
Overall height (mm)	213	313	363	513	663	813	963	1113	1263	1413	1563	1713	1863

EOS4 A / AH

WITH AUTOMATIC START/RESTART

A Models - Max. range: selectable 4 or 12 m

AH Models - Max. range: selectable 10 or 20 m



Resolution 50 mm	EOS4 155 A	EOS4 305 A	EOS4 455 A	EOS4 605 A	EOS4 755 A	EOS4 905 A	EOS4 1055 A	EOS4 1205 A	EOS4 1355 A	EOS4 1505 A	EOS4 1655 A	EOS4 1805 A
Ordering codes	1310400	1310401	1310402	1310403	1310404	1310405	1310406	1310407	1310408	1310409	1310470	1310471
Resolution 50 mm	EOS4 155AH	EOS4 305AH	EOS4 455AH	EOS4 605AH	EOS4 755AH	EOS4 905AH	EOS4 1055AH	EOS4 1205AH	EOS4 1355AH	EOS4 1505AH	EOS4 1655AH	EOS4 1805AH
Ordering codes	1310450	1310451	1310452	1310453	1310454	1310455	1310456	1310457	1310458	1310459	1310480	1310481
Protected height (mm)	160	310	460	610	760	910	1060	1210	1360	1510	1660	1810
Num. of beams	4	8	12	16	20	24	28	32	36	40	44	48
Overall height (mm)	213	363	513	663	813	963	1113	1263	1413	1563	1713	1863



Resolution 90 mm	EOS4 309 A	EOS4 459 A	EOS4 609 A	EOS4 759 A	EOS4 909 A	EOS4 1059 A	EOS4 1209 A	EOS4 1359 A	EOS4 1509 A	EOS4 1659 A	EOS4 1809 A
Ordering codes	1310501	1310502	1310503	1310504	1310505	1310506	1310507	1310508	1310509	1310570	1310571
Resolution 90 mm	EOS4 309AH	EOS4 459AH	EOS4 609AH	EOS4 759AH	EOS4 909AH	EOS4 1059AH	EOS4 1209AH	EOS4 1359AH	EOS4 1509AH	EOS4 1659AH	EOS4 1809AH
Ordering codes	1310551	1310552	1310553	1310554	1310555	1310556	1310557	1310558	1310559	1310580	1310581
Protected height (mm)	310	460	610	760	910	1060	1210	1360	1510	1660	1810
Num. of beams	4	6	8	10	12	14	16	18	20	22	24
Overall height (mm)	363	513	663	813	963	1113	1263	1413	1563	1713	1863



2, 3, 4 beams	EOS4 2B A	EOS4 3B A	EOS4 4B A
Ordering codes	1310600	1310601	1310602
2, 3, 4 beams	EOS4 2B AH	EOS4 3B AH	EOS4 4B AH
Ordering codes	1310650	1310651	1310652
Num. of beams	2	3	4
Beams spacing (mm)	500	400	300
Protected height (mm)	510	810	910
Overall height (mm)	653	953	1053

► **"ACCESSORIES" on page 69**

TYPE 4 SAFETY LIGHT CURTAIN

EOS4 X / XH WITH BUILT-IN CONTROL FUNCTIONS

MAIN FEATURES

Built-in, selectable manual/automatic Start/Restart.
 Max. range: up to 6 m for 14 mm resolution; up to 20 m for other models.
 Feedback input for external relays monitoring (EDM).
 Two safety PNP static outputs, auto-controlled.
 All connections and setting adjustments through M12 5-pole and 8-pole connectors.
 Unshielded cables up to 100 meter long.
 Master and Slave models for series connection of up to 3 light curtains.
 Max. length of connections toward Slaves: 50 meters, through standard unshielded cables.

TECHNICAL FEATURES

Safety level	Type 4 according to IEC/TS 61496-2 SIL 3 – SILCL 3 according to IEC 61508 - IEC 62061 PL e – Cat. 4 according to ISO 13849-1
Protected heights (mm)	160 ... 1810
Resolutions (mm)	14, 20, 30, 40, 50, 90
Numbers of beams for body detection in access control	2, 3, 4
Max. range (m)	selectable 3 or 6 for 14 mm resolution; selectable 4 or 12 for standard models; selectable 10 or 20 for H models with: 20, 30, 40, 50, 90 mm resolution and 2, 3, 4 beams:
Response time (ms)	2,5 ... 20
Safety outputs	2 PNP - 400 mA at 24 VDC with short-circuit, overload, polarity reversal protection
Signalling	LEDs for light curtain's status and diagnostic
Start/Restart	selectable automatic or manual
External Device Monitoring	external device monitoring feedback input with selectable enabling
Power Supply (VDC)	24 ± 20%
Electrical connections for EOS4 X and EOS4 X Master	M12 5-pole for emitter M12 8-pole for receiver
Electrical connections between Master and Slave	M12 - 5-pole for emitter and receiver
Max. cable length (m)	100 (50 between Master and Slave)
Operating temperature (°C)	-10 ... 55
Protection rating	IP 65 and IP 67
Fastening modes	back slot or to the top and lower end by rotating brackets SFB E180 (optional)
Cross section (mm)	28 x 30

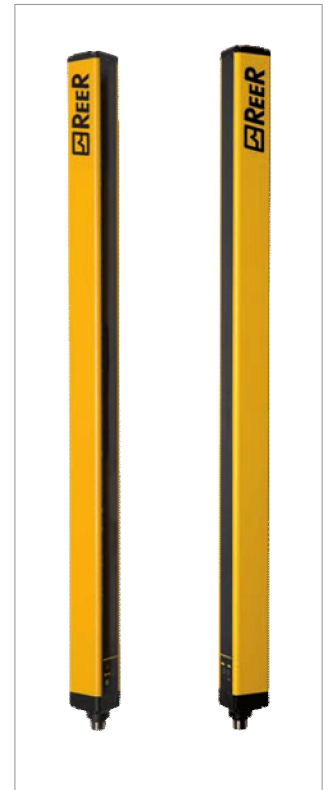

Emitter 5 poles

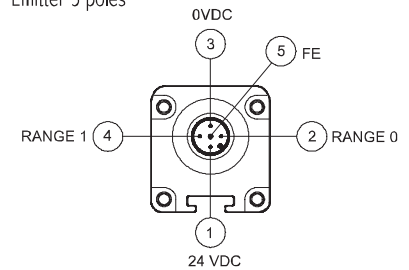

Receiver 8 poles

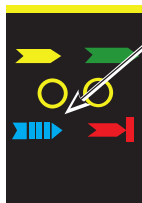
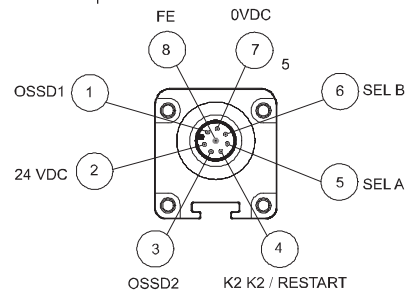

On the receivers of 14 mm resolution and H models a blue LED turns ON when the received beam signal intensity is weak.

During the alignment operations, checking the presence of the blue led weak signal is helpful. Upon completion of alignment and during normal operation, this LED must be off.



Safety level:

TYPE 4

SIL 3 – SILCL 3
PL e – Cat. 4

EOS4 X / XH

WITH BUILT-IN CONTROL FUNCTIONS

X Models 14 mm resolution - Max. range: selectable 3 or 6 m



Resolution 14 mm	EOS4 151 X	EOS4 301 X	EOS4 451 X	EOS4 601 X	EOS4 751 X	EOS4 901 X	EOS4 1051 X	EOS4 1201 X	EOS4 1351 X	EOS4 1501 X	EOS4 1651 X	EOS4 1801 X
Ordering codes	1310010	1310011	1310012	1310013	1310014	1310015	1310016	1310017	1310018	1310019	1310072	1310073
Protected height (mm)	160	310	460	610	760	910	1060	1210	1360	1510	1660	1810
Num. of beams	15	30	45	60	75	90	105	120	135	150	165	180
Overall height (mm)	213	363	513	663	813	963	1113	1263	1413	1563	1713	1863

X Models - Max. range: selectable 4 or 12 m
XH Models - Max. range: selectable 10 or 20 m



Resolution 20 mm	EOS4 152XH	EOS4 302XH	EOS4 452XH	EOS4 602XH	EOS4 752XH	EOS4 902XH	EOS4 1052XH	EOS4 1202XH	EOS4 1352XH	EOS4 1502XH	EOS4 1652XH	EOS4 1802XH
Ordering codes	1310160	1310161	1310162	1310163	1310164	1310165	1310166	1310167	1310168	1310169	1310182	1310183
Protected height (mm)	160	310	460	610	760	910	1060	1210	1360	1510	1660	1810
Num. of beams	15	30	45	60	75	90	105	120	135	150	165	180
Overall height (mm)	213	363	513	663	813	963	1113	1263	1413	1563	1713	1863



Resolution 30 mm	EOS4 153 X	EOS4 253 X	EOS4 303 X	EOS4 453 X	EOS4 603 X	EOS4 753 X	EOS4 903 X	EOS4 1053 X	EOS4 1203 X	EOS4 1353 X	EOS4 1503 X	EOS4 1653 X	EOS4 1803 X
Ordering codes	1310210	1311200	1310211	1310212	1310213	1310214	1310215	1310216	1310217	1310218	1310219	1310272	1310273
Resolution 30 mm	EOS4 153XH	-	EOS4 303XH	EOS4 453XH	EOS4 603XH	EOS4 753XH	EOS4 903XH	EOS4 1053XH	EOS4 1203XH	EOS4 1353XH	EOS4 1503XH	EOS4 1653XH	EOS4 1803XH
Ordering codes	1310260	-	1310261	1310262	1310263	1310264	1310265	1310266	1310267	1310268	1310269	1310282	1310283
Protected height (mm)	160	260	310	460	610	760	910	1060	1210	1360	1510	1660	1810
Num. of beams	8	13	16	23	31	38	46	53	61	68	76	83	91
Overall height (mm)	213	313	363	513	663	813	963	1113	1263	1413	1563	1713	1863



Resolution 40 mm	EOS4 154 X	EOS4 254 X	EOS4 304 X	EOS4 454 X	EOS4 604 X	EOS4 754 X	EOS4 904 X	EOS4 1054 X	EOS4 1204 X	EOS4 1354 X	EOS4 1504 X	EOS4 1654 X	EOS4 1804 X
Ordering codes	1310310	1311209	1310311	1310312	1310313	1310314	1310315	1310316	1310317	1310318	1310319	1310318	1310319
Resolution 40 mm	EOS4 154XH	-	EOS 304XH	EOS4 454XH	EOS4 604XH	EOS4 754XH	EOS4 904XH	EOS4 1054XH	EOS4 1204XH	EOS4 1354XH	EOS4 1504XH	EOS4 1654XH	EOS4 1803XH
Ordering codes	1310360	-	1310361	1310362	1310363	1310364	1310365	1310366	1310367	1310368	1310369	1310382	1310383
Protected height (mm)	160	260	310	460	610	760	910	1060	1210	1360	1510	1660	1810
Num. of beams	6	9	11	16	21	26	31	36	41	46	51	56	61
Overall height (mm)	213	313	363	513	663	813	963	1113	1263	1413	1563	1713	1863

TYPE 4 SAFETY LIGHT CURTAIN

EOS4 X / XH WITH BUILT-IN CONTROL FUNCTIONS

X Models - Max. range: selectable 4 or 12 m

XH Models - Max. range: selectable 10 or 20 m



Resolution 50 mm	EOS4 155 X	EOS4 305 X	EOS4 455 X	EOS4 605 X	EOS4 755 X	EOS4 905 X	EOS4 1055 X	EOS4 1205 X	EOS4 1355 X	EOS4 1505 X	EOS4 1655 X	EOS4 1805 X
Ordering codes	1310410	1310411	1310412	1310413	1310414	1310415	1310416	1310417	1310418	1310419	1310472	1310473
Resolution 50 mm	EOS4 155XH	EOS4 305XH	EOS4 455XH	EOS4 605XH	EOS4 755XH	EOS4 905XH	EOS4 1055XH	EOS4 1205XH	EOS4 1355XH	EOS4 1505XH	EOS4 1655XH	EOS4 1805XH
Ordering codes	1310460	1310461	1310462	1310463	1310464	1310465	1310466	1310467	1310468	1310469	1310482	1310483
Protected height (mm)	160	310	460	610	760	910	1060	1210	1360	1510	1660	1810
Num. of beams	4	8	12	16	20	24	28	32	36	40	44	48
Overall height (mm)	213	363	513	663	813	963	1113	1263	1413	1563	1713	1863



Resolution 90 mm	EOS4 309 X	EOS4 459 X	EOS4 609 X	EOS4 759 X	EOS4 909 X	EOS4 1059 X	EOS4 1209 X	EOS4 1359 X	EOS4 1509 X	EOS4 1659 X	EOS4 1809 X
Ordering codes	1310511	1310512	1310513	1310514	1310515	1310516	1310517	1310518	1310519	1310572	1310573
Resolution 90 mm	EOS4 309XH	EOS4 459XH	EOS4 609XH	EOS4 759XH	EOS4 909XH	EOS4 1059XH	EOS4 1209XH	EOS4 1359XH	EOS4 1509XH	EOS4 1659XH	EOS4 1809XH
Ordering codes	1310561	1310562	1310563	1310564	1310565	1310566	1310567	1310568	1310569	1310582	1310583
Protected height (mm)	310	460	610	760	910	1060	1210	1360	1510	1660	1810
Num. of beams	4	6	8	10	12	14	16	18	20	22	24
Overall height (mm)	363	513	663	813	963	1113	1263	1413	1563	1713	1863



2, 3, 4 beams	EOS4 2B X	EOS4 3B X	EOS4 4B X
Ordering codes	1310610	1310611	1310612
2, 3, 4 beams	EOS4 2B XH	EOS4 3B XH	EOS4 4B XH
Ordering codes	1310660	1310661	1310662
Num. of beams	2	3	4
Beams spacing (mm)	500	400	300
Protected height (mm)	510	810	910
Overall height (mm)	653	953	1053

► "ACCESSORIES" on page 69

EOS4 XM / XS / XS2 MASTER/SLAVE MODELS WITH BUILT-IN CONTROL FUNCTIONS

MASTER/SLAVE MODELS

Master, Slave models permit series connection of up to three light curtains and combined detection of hand and presence of a person or of more sides of the machine, with the following major benefits:

- A single pair of safety outputs.
- No interference between light curtains installed adjacent to one another.

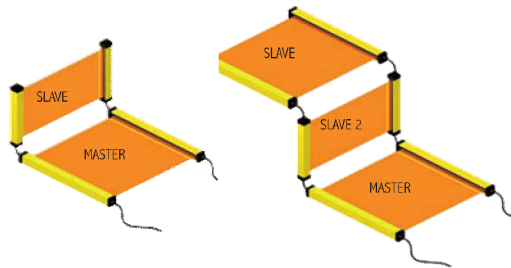

EXAMPLES OF SERIES CONNECTION OF MASTER AND SLAVE LIGHT CURTAINS

Any Master model can be used together with any Slave model.

All electrical connections are made using M12 5-pole connectors, except for Master receivers which necessitate the adoption of M12 8-pole connectors.

Pre-wired cables with twin connectors are available for the connection between Master and Slave.

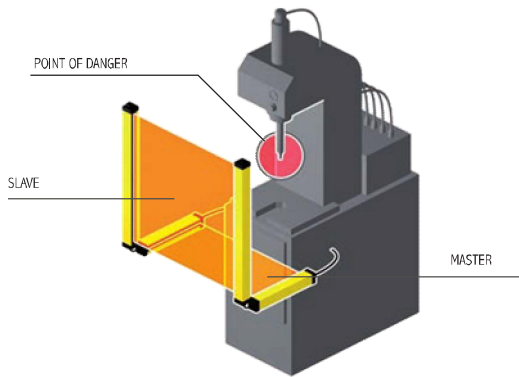

EXAMPLES OF SERIES CONNECTION OF MASTER AND SLAVE LIGHT CURTAINS

Master light curtain is placed horizontally for detection of the person and Slave light curtain is placed vertically to detect fingers or hands.

The arrangement can be reversed to have the Master light curtain vertical for finger and hand detection and the Slave light curtain horizontally for detecting the presence of a person.

The application shown is one of the most common: horizontal curtains are used to prevent the operator from being undetected in the space between vertical light curtain and dangerous machine, upon system start-up or restarting.

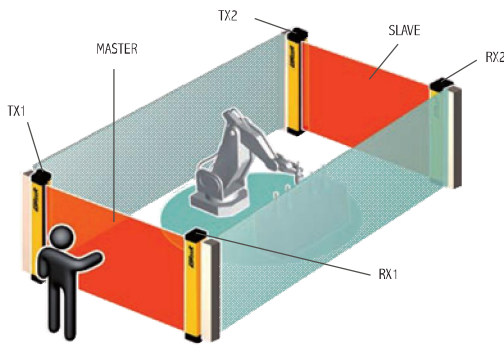

EXAMPLE OF SERIES CONNECTION OF MASTER AND SLAVE LIGHT CURTAINS FOR PROTECTION OF TWO SIDES OF THE MACHINE

On EOS4 X the connecting cable across Master and Slave is a standard (unshielded) cable up to 50 meter long.

Thus, two series connected curtains may be located one at the front of the machine and the other at the rear, with a single connection to the machine power and control circuitry.



EXAMPLE OF SERIES CONNECTION OF ONE MASTER AND TWO SLAVE LIGHT CURTAINS FOR THE PROTECTION OF THREE SIDES OF THE MACHINE

Benefit: unimpeded operator access to work area from front and sides.

TYPE 4 SAFETY LIGHT CURTAIN

EOS4 XM / XS / XS2

MASTER/SLAVE MODELS WITH BUILT-IN CONTROL FUNCTIONS

Series connections diagram

Benefit:

with three standard curtains it will be necessary to use and wire up 3 safety interfaces or 6 contactors.

With the master, slave solution having 3 series light curtains it will be enough to use and wire up only 1 safety interface or 2 contactors.

MASTER/SLAVE MODELS

Max. range: selectable 3 or 6 m

MASTER		EOS4	EOS4	EOS4	EOS4	EOS4	EOS4	EOS4	EOS4	EOS4	EOS4	EOS4	EOS4
Resolution	-	301	451	601	751	901	1051	1201	1351	1501	1651	1801	1801
14 mm		XM	XM	XM	XM	XM	XM	XM	XM	XM	XM	XM	XM
Ordering codes	-	1310021	1310022	1310023	1310024	1310025	1310026	1310027	1310028	1310029	1310074	1310075	
SLAVE	EOS4	EOS4	EOS4	EOS4	EOS4	EOS4	EOS4	EOS4	EOS4	EOS4	EOS4	EOS4	EOS4
Resolution	151	301	451	601	751	901	1051	1201	1351	1501	1651	1801	1801
14 mm	XS	XS	XS	XS	XS	XS	XS	XS	XS	XS	XS	XS	XS
Ordering codes	1310030	1310031	1310032	1310033	1310034	1310035	1310036	1310037	1310038	1310039	1310076	1310076	
SLAVE 2		EOS4	EOS4	EOS4	EOS4	EOS4	EOS4	EOS4	EOS4	EOS4	EOS4	EOS4	EOS4
Resolution	-	301	451	601	751	901	1051	1201	1351	1501	1651	1801	1801
14 mm		XS2	XS2	XS2	XS2	XS2	XS2	XS2	XS2	XS2	XS2	XS2	XS2
Ordering codes	-	1310041	1310042	1310043	1310044	1310045	1310046	1310047	1310048	1310049	1310078	1310079	
Protected height (mm)	160	310	460	610	760	910	1060	1210	1360	1510	1660	1810	
Num. of beams	15	30	45	60	75	90	105	120	135	150	165	180	
Overall height (mm) *	236.5	386.5	536.5	686.5	836.5	986.5	1136.5	1286.5	1436.5	1586.5	1736.5	1886.5	

Max. range: selectable 4 or 12 m

MASTER		EOS 4	EOS4	EOS4	EOS4	EOS4	EOS4	EOS4	EOS4	EOS4	EOS4	EOS4	EOS4
Resolution	-	253	303	453	603	753	903	1053	1203	1353	1503	1653	1803
30 mm		XM	XM	XM	XM	XM	XM	XM	XM	XM	XM	XM	XM
Ordering codes	-	1311206	1310221	1310222	1310223	1310224	1310225	1310226	1310227	1310228	1310229	1310274	1310275
SLAVE	EOS4	EOS 4	EOS4	EOS4	EOS4	EOS4	EOS4	EOS4	EOS4	EOS4	EOS4	EOS4	EOS4
Resolution	153	253	303	453	603	753	903	1053	1203	1353	1503	1653	1803
30 mm	XS	XS	XS	XS	XS	XS	XS	XS	XS	XS	XS	XS	XS
Ordering codes	1310230	1311207	1310231	1310232	1310233	1310234	1310235	1310236	1310237	1310238	1310239	1310276	1310277
SLAVE 2		EOS 4	EOS4	EOS4	EOS4	EOS4	EOS4	EOS4	EOS4	EOS4	EOS4	EOS4	EOS4
Resolution	-	253	303	453	603	753	903	1053	1203	1353	1503	1653	1803
30 mm		XM2	XS2	XS2	XS2	XS2	XS2	XS2	XS2	XS2	XS2	XS2	XS2
Ordering codes	-	1311208	1310241	1310242	1310243	1310244	1310245	1310246	1310247	1310248	1310249	1310278	1310279
Protected height (mm)	160	260	310	460	610	760	910	1060	1210	1360	1510	1660	1810
Num. of beams	8	13	16	23	31	38	46	53	61	68	76	83	91
Overall height (mm) *	236.5	336.5	386.5	536.5	686.5	836.5	986.5	1136.5	1286.5	1436.5	1586.5	1736.5	1886.5

EOS4 XM / XS / XS2

MASTER/SLAVE MODELS WITH BUILT-IN CONTROL FUNCTIONS

Max. range: selectable 4 or 12 m



MASTER Resolution 40 mm	-	EOS4 254 XM	EOS4 304 XM	EOS4 454 XM	EOS4 604 XM	EOS4 754 XM	EOS4 904 XM	EOS4 104 XM	EOS4 1204 XM	EOS4 1354 XM	EOS4 1504 XM	EOS4 1654 XM	EOS4 1804 XM
Ordering codes	-	1311210	1310321	1310322	1310323	1310324	1310325	1310326	1310327	1310328	1310329	1310374	1310375
SLAVE Resolution 40 mm	EOS4 154 XS	EOS 4 254 XS	EOS4 304 XS	EOS4 454 XS	EOS4 604 XS	EOS4 754 XS	EOS4 904 XS	EOS4 1054 XS	EOS4 1204 XS	EOS4 1354 XS	EOS4 1504 XS	EOS4 1654 XS	EOS4 1804 XS
Ordering codes	1310330	1311211	1310331	1310332	1310333	1310334	1310335	1310336	1310337	1310338	1310339	1310376	1310377
SLAVE 2 Resolution 40 mm	-	EOS4 254 XM2	EOS4 304 XS2	EOS4 454 XS2	EOS4 604 XS2	EOS4 754 XS2	EOS4 904 XS2	EOS4 1054 XS2	EOS4 1204 XS2	EOS4 1354 XS2	EOS4 1504 XS2	EOS4 1654 XS2	EOS4 1804 XS2
Ordering codes	-	1311212	1310341	1310342	1310343	1310344	1310345	1310346	1310347	1310348	1310349	1310378	1310379
Protected height (mm)	160	260	310	460	610	760	910	1060	1210	1360	1510	1660	1810
Num. of beams	6	9	11	16	21	26	31	36	41	46	51	56	61
Overall height (mm) *	236.5	336.5	386.5	536.5	686.5	836.5	986.5	1136.5	1286.5	1436.5	1586.5	1736.5	1886.5



MASTER Resolution 50 mm	-	EOS4 305 XM	EOS4 455 XM	EOS4 605 XM	EOS4 755 XM	EOS4 905 XM	EOS4 105 XM	EOS4 1205 XM	EOS4 1355 XM	EOS4 1505 XM	EOS4 1655 XM	EOS4 1805 XM
Ordering codes	-	1310421	1310422	1310423	1310424	1310425	1310426	1310427	1310428	1310429	1310474	1310475
SLAVE Resolution 50 mm	EOS4 155 XS	EOS4 305 XS	EOS4 455 XS	EOS4 605 XS	EOS4 755 XS	EOS4 905 XS	EOS4 1055 XS	EOS4 1205 XS	EOS4 1355 XS	EOS4 1505 XS	EOS4 1655 XS	EOS4 1805 XS
Ordering codes	1310430	1310431	1310432	1310433	1310434	1310435	1310436	1310437	1310438	1310439	1310476	1310477
SLAVE 2 Resolution 50 mm	-	EOS4 305 XS2	EOS4 455 XS2	EOS4 605 XS2	EOS4 755 XS2	EOS4 905 XS2	EOS4 1055 XS2	EOS4 1205 XS2	EOS4 1355 XS2	EOS4 1505 XS2	EOS4 1655 XS2	EOS4 1805 XS2
Ordering codes	-	1310441	1310442	1310443	1310444	1310445	1310446	1310447	1310448	1310449	1310478	1310479
Protected height (mm)	160	310	460	610	760	910	1060	1210	1360	1510	1660	1810
Num. of beams	4	8	12	16	20	24	28	32	36	40	44	48
Overall height (mm) *	236.5	386.5	536.5	686.5	836.5	986.5	1136.5	1286.5	1436.5	1586.5	1736.5	1886.5

TYPE 4 SAFETY LIGHT CURTAIN

EOS4 XM / XS / XS2

MASTER/SLAVE MODELS WITH BUILT-IN CONTROL FUNCTIONS

Max. range: selectable 4 or 12 m



MASTER Resolution 90 mm	EOS4 309 XM	EOS4 459 XM	EOS4 609 XM	EOS4 759 XM	EOS4 909 XM	EOS4 1059 XM	EOS4 1209 XM	EOS4 1359 XM	EOS4 1509 XM	EOS4 1659 XM	EOS4 1809 XM
Ordering codes	1310521	1310522	1310523	1310524	1310525	1310526	1310527	1310528	1310529	1310574	1310575
SLAVE Resolution 90 mm	EOS4 309 XS	EOS4 459 XS	EOS4 609 XS	EOS4 759 XS	EOS4 909 XS	EOS4 1059 XS	EOS4 1209 XS	EOS4 1359 XS	EOS4 1509 XS	EOS4 1659 XS	EOS4 1809 XS
Ordering codes	1310531	1310532	1310533	1310534	1310535	1310536	1310537	1310538	1310539	1310576	1310577
SLAVE 2 Resolution 90 mm	EOS4 309 XS2	EOS4 459 XS2	EOS4 609 XS2	EOS4 759 XS2	EOS4 909 XS2	EOS4 1059 XS2	EOS4 1209 XS2	EOS4 1359 XS2	EOS4 1509 XS2	EOS4 1659 XS2	EOS4 1809 XS2
Ordering codes	1310541	1310542	1310543	1310544	1310545	1310546	1310547	1310548	1310549	1310578	1310579
Protected height (mm)	310	460	610	760	910	1060	1210	1360	1510	1660	1810
Num. of beams	4	6	8	10	12	14	16	18	20	22	24
Overall height (mm) *	386.5	536.5	686.5	836.5	986.5	1136.5	1286.5	1436.5	1586.5	1736.5	1886.5



MASTER 2, 3, 4 beams	EOS4 2B XM	EOS4 3B XM	EOS4 4B XM
Ordering codes	1310620	1310621	1310622
SLAVE 2, 3, 4 beams	EOS4 2B XS	EOS4 3B XS	EOS4 4B XS
Ordering codes	1310630	1310631	1310632
SLAVE 2 2, 3, 4 beams	EOS4 2B XS2	EOS4 3B XS2	EOS4 4B XS2
Ordering codes	1310640	1310641	1310642
Num. of beams	2	3	4
Beams spacing (mm)	500	400	300
Protected height (mm)	510	810	910
Overall height (mm)*	677	977	1077

* On slave models, the overall height of the light curtain is the same of the standard model.
On Master and Slave2, the total height of the light curtain is greater due to the addition of a secondary connector.

► "ACCESSORIES" on page 69

EOS4

DIMENSIONS (mm)

EOS4 / EOS4 SLAVE

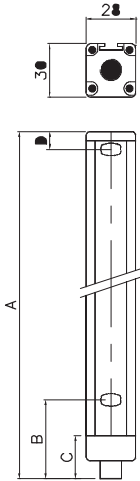

EOS4 MASTER / EOS4 SLAVE 2

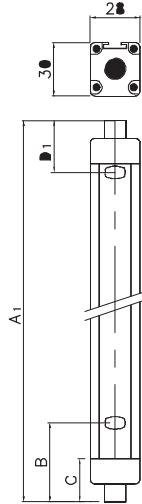

Model	2B	3B	4B
A	653	953	1053
A ₁ (Master/Slave2)	677	977	1077
B		102	
C		29.5	
D		51	
D ₁ (Master/Slave2)		75	

Model	150	250	300	450	600	750	900	1050	1200	1350	1500	1650	1800
A	213	313	363	513	663	813	963	1113	1263	1413	1563	1713	1863
A ₁ (Master/Slave2)	236.5	336.5	386.5	536.5	686.5	836.5	986.5	1136.5	1286.5	1436.5	1586.5	1736.5	1886.5
B								61.5					
C								29.5					
D								11					
D ₁ (Master/Slave 2)								34.5					
Mounting	Complete set of 4 LE type brackets included in the package							Complete set of 6 LE type brackets included in the package					



WARNING!

Where the light curtain is subjected to strong vibrations (presses, textile looms, etc.) always use vibrations dampers SAV E (available as accessories) in order to prevent damaging the light curtain.

Where protections are to be placed over long distances or on several sides using deflection mirrors, it is advisable to use laser alignment aid LAD 4 to ensure simple, quick and perfect alignment of light curtains.

ORDERING INFORMATION

Each EOS4 light curtain comprises:

Emitter and Receiver pair	CD-ROM containing the multi-language instruction manual complete with CE declaration of conformity
Brackets and inserts	Quick installation guide

ACCESSORIES

For EOS4 light curtains the following accessories, to be ordered separately, are available:

AD SR Safety relays	▶ See page 183
FMC floor mounting columns	▶ See page 220
SP deflection mirrors	▶ See page 223
LAD laser alignment device	▶ See page 224
SAV E vibrations dampers	▶ See page 225
SFB swivel fixing brackets	▶ See page 226
Connectors	▶ See list hereunder:

CONNECTORS (EOS4 A emitter and receiver / EOS4 X emitter)

Model	Code	Description
CD 5	1330950	M12 straight connector 5 poles pre-wired, cable 5 m
CD 10	1330956	M12 straight connector 5 poles pre-wired, cable 10 m
CD 15	1330952	M12 straight connector 5 poles pre-wired, cable 15 m
CD 20	1330957	M12 straight connector 5 poles pre-wired, cable 20 m
CD 25	1330949	M12 straight connector 5 poles pre-wired, cable 25 m
CD 50	1330965	M12 straight connector 5 poles pre-wired, cable 50 m
CD 95	1330951	M12 90° angle connector 5 poles pre-wired, cable 5 m
CD 910	1330958	M12 90° angle connector 5 poles pre-wired, cable 10 m
CD 915	1330953	M12 90° angle connector 5 poles pre-wired, cable 15 m
CDM 9	1330954	M12 straight connector 5 poles with screw terminal, PG9 cable gland
CDM 99	1330955	M12 90° angle connector, 5 poles with screw terminal, PG9 cable gland

CONNECTORS EOS4 (X receiver)

Model	Code	Description
C8D 5	1330980	M12 straight connector 8 poles pre-wired, cable 5 m
C8D 10	1330981	M12 straight connector 8 poles pre-wired, cable 10 m
C8D 15	1330982	M12 straight connector 8 poles pre-wired, cable 15 m
C8D 25	1330967	M12 straight connector 8 poles pre-wired, cable 25 m
C8D 40	1440966	M12 straight connector 8 poles pre-wired, cable 40 m
C8D 95	1330983	M12 90° angle connector 8 poles pre-wired, cable 5 m
C8D 910	1330984	M12 90° angle connector 8 poles pre-wired, cable 10 m
C8D 915	1330985	M12 90° angle connector 8 poles pre-wired, cable 15 m
C8DM 11	1330978	M12 straight connector 8 poles with screw terminal, PG9/11 cable gland
C8DM 911	1330979	M12 90° angle connector 8 poles with screw terminal, PG9/11 cable gland

CONNECTION BETWEEN MASTER AND SLAVE

Model	Code	Description
CDS 03	1330990	0,3 m pre-wired cable with 2 straight connectors M12 5-pole
CIBE 3	1360960	3 m pre-wired cable with 2 straight connectors M12 5-pole
CIBE 5	1360961	5 m pre-wired cable with 2 straight connectors M12 5-pole
CIBE 10	1360962	10 m pre-wired cable with 2 straight connectors M12 5-pole
CIBE 25	1360963	25 m pre-wired cable with 2 straight connectors M12 5-pole

