



Photoelectric Communication Sensor





## XPC – Extremely Versatile Photoelectric Communication Sensor

The **SMARTEYE® X-PRO XPC** is the most versatile Photoelectric Communication Sensor available on the market. Its patented communication technology allows for instant access, as well as feedback to and from the sensor. This unique photoelectric sensor is designed to be used in any application where physical contact of the sensor is either restricted, undesirable, or adds too much time to production line throughput. The **SMARTEYE® X-PRO XPC** sensor is just the kind of sensor innovation you would expect from Tri-Tronics. We've been pushing the envelope for half a century and continue to offer customers superior performance sensors for their unique application requirements.

The XPC is available in two communications options; RS-485 for multi-drop applications where sensors need to be addressed and bussed together, or RS-232 for single-drop applications where the sensor is behind safety interlocks, or in hard-to-reach areas that restrict easy access. These sensors can be easily interfaced to HMI's or PLC's using MODBUS ASCII or RTU communication protocol. Our unique and comprehensive EyewareXPC software is free of charge in either the development kit or upon request from the factory. We can also custom configure software requirements. **Please consult the factory for details.**

No other communication sensor available on the market provides this kind of accessibility, control, and flexibility. *The SMARTEYE® X-PRO XPC Photoelectric Communication Sensor by Tri-Tronics, another breakthrough technology from a world class leader in innovation.*



### Features

- n Downloadable Recipes
- n Half-Duplex Communication
  - RS-485 (multi-drop) or RS-232 (single drop)
  - MODBUS ASCII or RTU
- n Five Onboard Memory Locations
- n Button Lockout
- n Configurable Response Time: 60µs, 125µs, or 450µs
- n 8-Pin Male, M12 Connector
- n Available in White, Red, or Infrared LED
- n Patent No.'s 5,621,205 and 6,950,778
- n 10-LED Dual-Function Bar Graph
- n EyewareXPC Software Includes:
  - Two 4-Segment Digital Displays (Signal Level & Threshold)
  - Digital Sensor Scope
  - Full Featured Command Set

*Note: EyewareXPC is free demonstration software. Command Set also available for custom interface software.*

### Benefits

- n P.A.T. Compliant Process Analytical Technology
- n No-Touch Setup
- n Quick Digital Changeover
- n Tamperproof
- n Capture and Save Setups
- n Log Sensor Performance
- n Digital Process Validation
- n Performance Calibration
- n Universal Application Flexibility
- n Quality Verification

# Applications

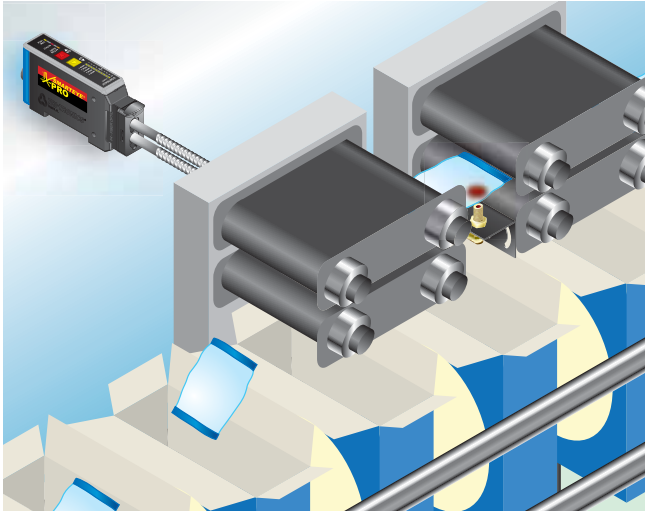

Coupon Dispensing - Use Downloadable Recipes for Quick Digital Changeover

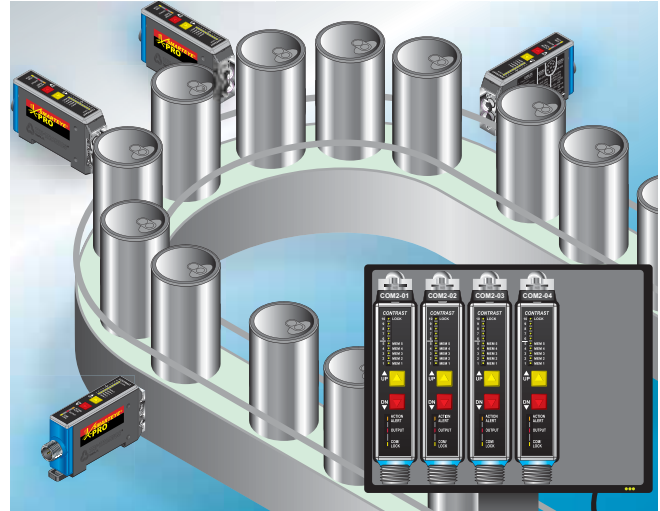

Access All Sensors from One Location for Process Validation and Monitoring

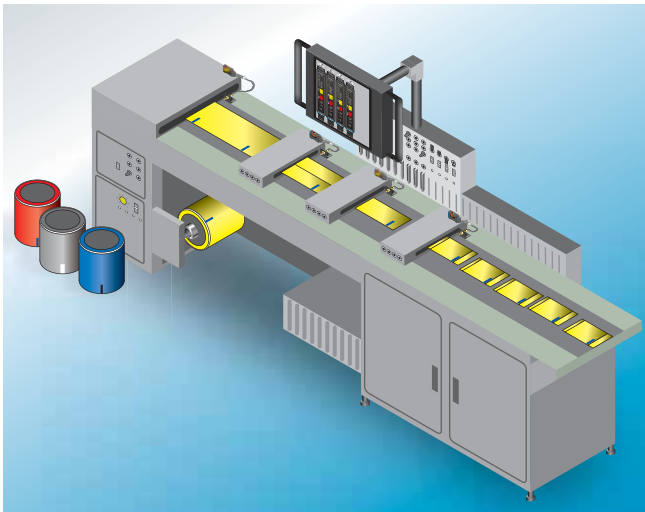

Conversion Machine with Multiple Sensors - Use Downloadable Recipes for Quick Digital Changeover

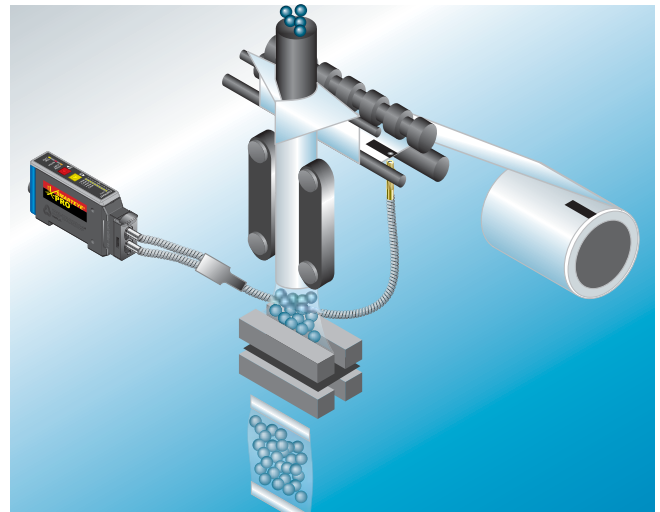

Form, Fill, & Seal - Registration Mark Sensing with Downloadable Recipes

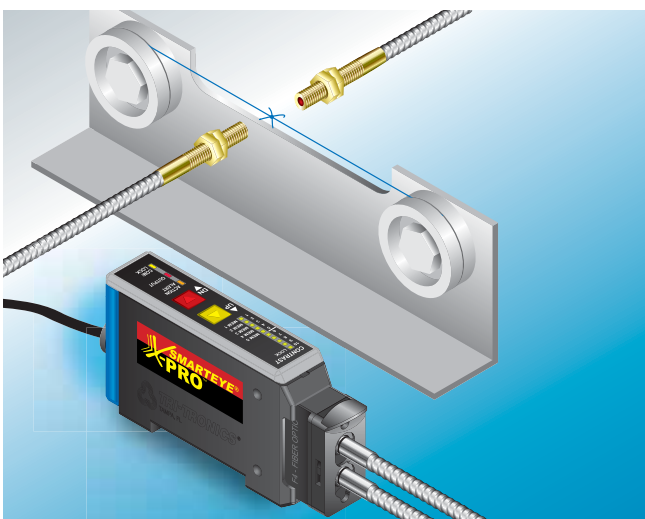

Suture Knot Detection - Use Threshold Adjustment with Digital Sensor Scope to Optimize Performance

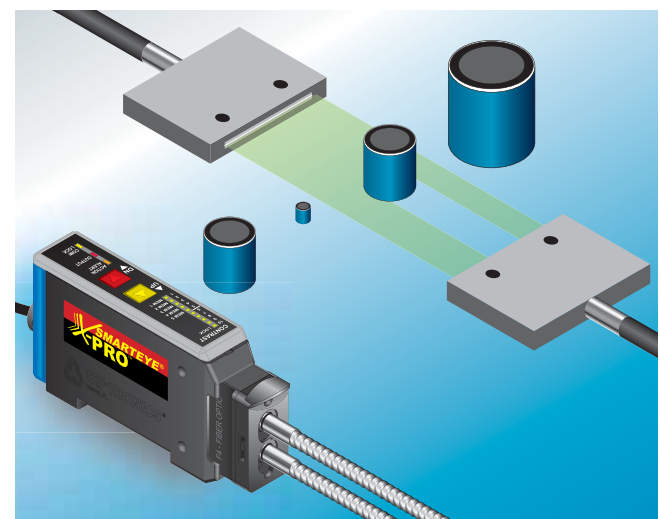

Sort Parts by Size - Use Digital Display of Sensor Signal Level for Part Profiling

# Features



## 10 LED DUAL-FUNCTION BAR GRAPH

**Contrast Indicator** – Provides “at-a-glance” performance data.  
**Lock** – When this option is enabled the sensor becomes tamperproof. Note: The remote AUTOSET and programming are not affected by the Lock option.  
**MEM 1 through MEM 5** - LED indicates MEM location selected.  
*NOTE: Any changes to the sensor will automatically be saved to current MEM # location.*

## EDR® (Patent No. 5,621,205)

EDR® (Enhanced Dynamic Range) circuit prevents dark state saturation and expands the operating range without reducing amplifier gain.

## ACT

ACT (Automatic Contrast Tracking) automatically adjusts the sensor for diminishing conditions. Ex. Dirty environment, scratched lenses, thermal drift, or LED light power.

## AGS

AGS (Automatic Gain Select) is an unique feature that provides automatic

digital selection of amplifier gain based upon your sensing requirements.

## AUTOSET ADJUSTMENT

The AUTOSET adjustment routine only requires the push of one button, one time. Oftentimes, in dynamic operating conditions, all you have to do is push the button for a perfect setting. This is dependent upon at least a 4:1 duty cycle ratio.

(Note: The buttons on the sensor are inactive when in communication mode; if COM/LOCK LED is on or blinking)

## COMMUNICATIONS

RS-485 or RS-232 in either MODBUS ASCII or MODBUS RTU protocol. Up to 128 sensors per node, more-or-less, depending on cable length. Baud rate and addresses are user selected and defined when utilizing the EyewareXPC software, or proper commands as defined by the Command Set. When using EyewareXPC software, simply tap the Communications button located on Screen 2 in order to access the Baud Rate or Address widows.

## RESPONSE TIME SELECTION

60µs, 125µs, and 450µs available.

## AUX IO

AUX IO line can be configured as:  
 • Remote AUTOSET  
 Remotely AUTOSET the sensor by applying a momentary contact closure from the Remote AUTOSET input wire to negative as shown in the wiring diagram. The Remote AUTOSET command will duplicate the last manual AUTOSET.  
 • Remote Input  
 • Action Alert Output  
 • Output Mode: On  
 • Output Mode: Off

*Note: Configure AUX IO by using complimentary EyewareXPC software or Full Featured Command Set.*

## CONNECTIONS

Built-in 8-pin M12 Connector.

## MOUNTING OPTIONS

Built-in DIN rail “Snap-On” design, through hole, or bracket mount.

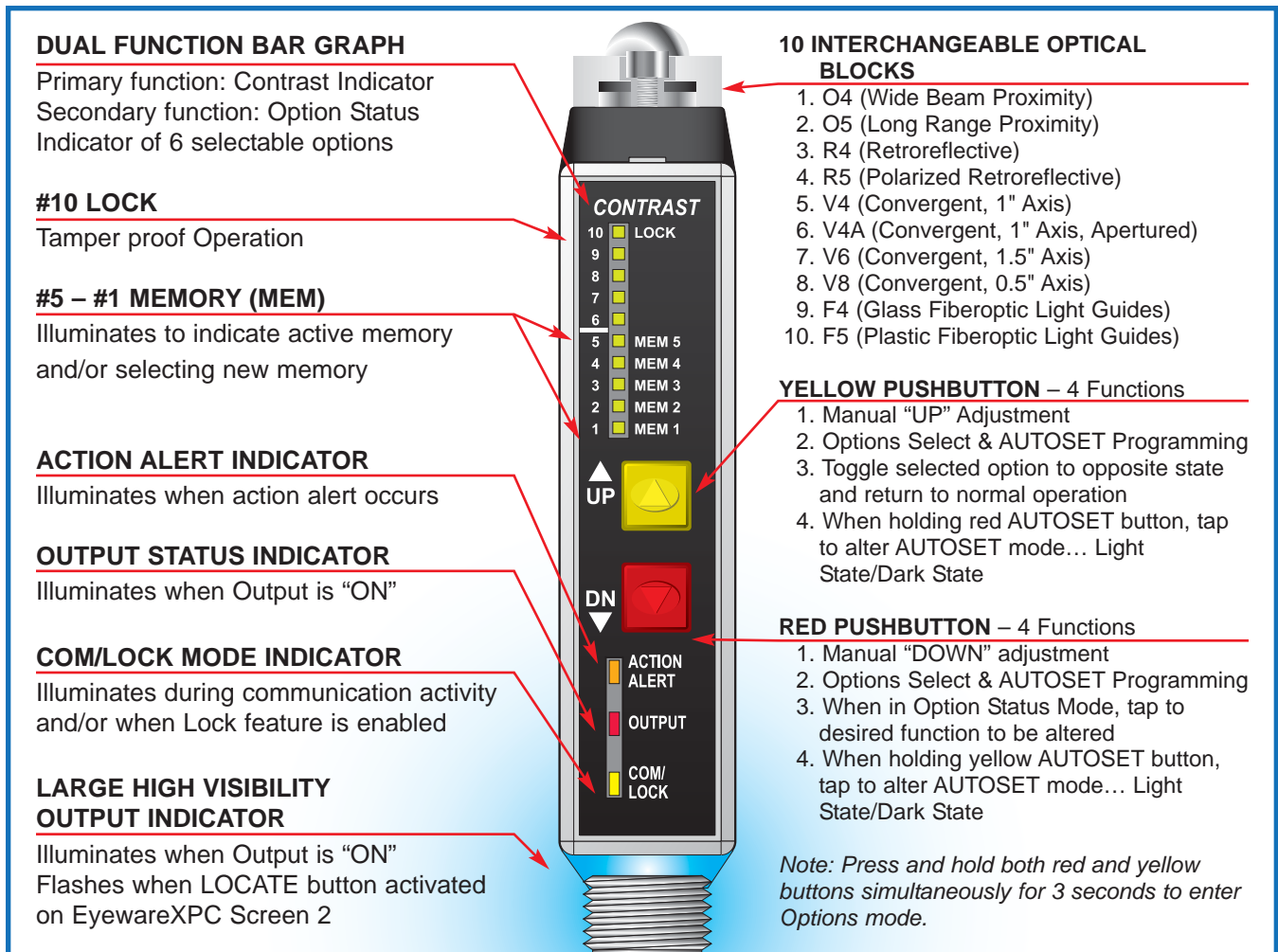

# Special Features



## EyewareXPC Software - Complimentary

*EyewareXPC is a free diagnostic tool to aid the user in setting up, testing, and debugging applications. Write your own custom controls using the available full featured Command Set.*

**Note: EyewareXPC Software works only with modbus ASCII versions of XPC.**

## Addressable

RS-485 Multidrop. Distinct, customer defined addresses. Up to 128 sensors on one Network.

## On-Screen Adjustment

Buttons are active on screen...manually adjust the sensor UP or DOWN for precise sensor setup.

## Output LED

The blue and red LED Output Indicators are active on the screen and turn on when the output is activated.

## Contrast Indicator

These 10 LEDs are active on the screen and respond up and down to each sensor's received light level.

Screen One



Load	Save	Sensors	Help
"Load" - Recipe Load	"Save" - Save Recipes & Configurations	"Sensors..." - Locate, Add or Connect Sensors	"Help" - EyewareXPC Details

# Detailed Features

**"Click" or "Touch"** an area of the sensor on the screen, other than the red/yellow buttons, and you will advance to the screen below, Screen Two. To return to the multi-sensor screen view, or Screen One, click on the Back button in the lower right corner.

This area is feature rich with many buttons available to customize any sensing solution.

**AUTOSET** Performs previous AUTOSET function

**AUTOSET Options...** Change hysteresis multiplier, and set point percentage

• 4 AUTOSET Buttons -

Light On / Light State    Dark On / Light State

Light On / Dark State    Dark On / Dark State

**AUX Mode...** Change auxiliary line to Remote AUTOSET, Remote Input, Action Alert, or Input/Output

**Locate** Blinks the blue output LED on the back of the sensor

**Button Lockout** Locks the buttons on the sensor to make it tamperproof

**Memory...** Selection of MEM 1 through 5

**Processing...** Change response time, Light On/Dark On, and activate Automatic Contrast Tracking (ACT™)

**Communications...** Select Baud rate and device address

**Post-Processing...** Select and alter time delays, and output invert

• **Sensor Scope** - Analyze received light levels, threshold settings, and hysteresis ON/OFF points



All of these features are detailed in the Help button in the lower right corner.

# Optical Block Selection



The SMARTEYE® X-PRO XPC gives you a choice of 10 interchangeable optical blocks, making it one of the most versatile sensors on the market today.

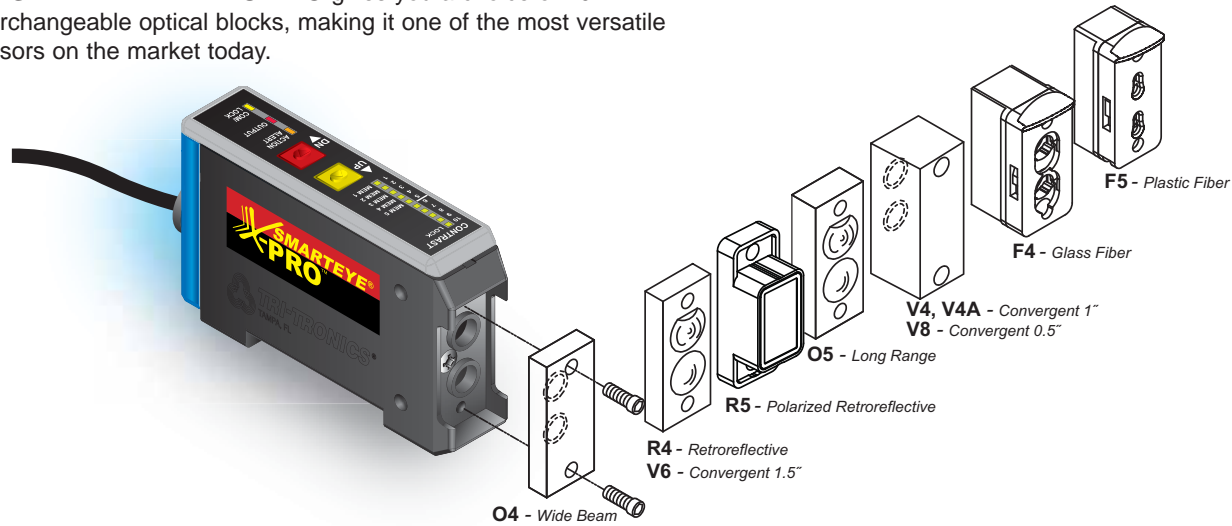

### Type O4 Proximity

Wide beam optics useful for short-range sensing of transparent, translucent, opaque, or irregular shaped shiny objects.

### Type O5 Proximity

Narrow beam optics useful in long-range sensing of medium to large size objects.

### Type R4 Retroreflective

Very narrow beam optics designed to sense reflectors or reflective materials at long range. Designed for Beam Break sensing.

### Type R5 Polarized Anti-Glare Retroreflective

Polarized to reduce response to "hot spot" glare from shiny surface of detected object. Use with visible light source.

### Type F4 Glass Fiberoptics

Adapter for use with a wide variety of glass fiberoptic light guides for both the proximity and opposed sensing modes.

### Type F5 Plastic Fiberoptics

Adapter for use with a wide variety of plastic fiberoptic light guides for both the proximity and opposed sensing modes

### Type V4, V4A Convergent 1" "V" Axis

Useable range of 1" to 5".

### Type V6 Convergent 1.5" "V" Axis

Useable range of 1.5" to 8".

### Type V8 Convergent .5" "V" Axis

Useable range of .25" to 5"

Narrow beam optics useful for sensing small parts or registration color marks. Also useful for proximity sensing to minimize response to reflected light from background objects..

## Sensing Range Guidelines

Convert to Inches  
25.4mm = 1"

Speed Setting Sensing Mode		60µs Reflective			125µs Reflective			450µs Reflective		
Fiber	Block	IR	Red	White	IR	Red	White	IR	Red	White
Glass Fibers	F4	89mm	63mm	76mm	178mm	115mm	102mm	229mm	127mm	115mm
	F4 w/UAC-15	178mm	152mm	203mm	330mm	330mm	330mm	356mm	357mm	356mm
Plastic Fibers	F5	N/A	38mm	95mm	N/A	44mm	115mm	N/A	59mm	127mm
	F5 w/HLA-2	N/A	102mm	57mm	N/A	140mm	76mm	N/A	152mm	83mm
Speed Setting Sensing Mode		60µs Opposed			125µs Opposed			450µs Opposed		
Fiber	Block	IR	Red	White	IR	Red	White	IR	Red	White
Glass Fibers	F4	254mm	203mm	356mm	406mm	305mm	457mm	610mm	357mm	559mm
	F4 w/UAC-15	4.6M	3.7M	6+M	6+M	5.5M	6+M	6+M	6+M	6+M
Plastic Fibers	F5	N/A	127mm	115mm	N/A	203mm	152mm	N/A	241mm	165mm
	F5 w/GLA-2	N/A	1.2M	1.1M	N/A	2.1M	9.5M	N/A	2.5M	1.5M
Lens Blocks		60µs			125µs			450µs		
		IR	Red	White	IR	Red	White	IR	Red	White
	O4 SR Proximity	178mm	127mm	203mm	279mm	203mm	254mm	406mm	229mm	305mm
	O5 LR Proximity	1.1M	813mm	610mm	254mm	1.3M	9.1M	2.4M	1.5M	965mm
	R4 Retro	4.6M	5.5M	3M	7.6M	8.2M	4.3M	9.1M	8.5M	4.6M
	R4 Retro wo/prox	1.5M	2.8M	1.1M	2.4M	2.7M	762mm	1.5M	2.7M	1.1M
	R5 Polarized Retro	N/A	2.1M	N/A	N/A	2.1M	N/A	N/A	2.1M	N/A

Note: Proximity tests utilized a 90% reflective white target. Retroreflective tests utilized a 3" (76.2mm) diameter round reflector, Model AR3.

Note: R4 retroreflective tests utilized a Kraft paper target, with no proxing.

Note: Glass fiber tests utilized a .125" (3.175mm) diameter fiber bundle. Plastic fiber tests utilized a diplex, .040" (1.016mm) diameter fiber bundle.

# How to Specify



## 1. Select Sensor

Communication Type required:

- XPC2 = RS-232 MODBUS ASCII
- XPC3 = RS-232 MODBUS RTU
- XPC4 = RS-485 MODBUS ASCII
- XPC5 = RS-485 MODBUS RTU

## 2. Select Sensor LED Light Source required:

- I = Infrared
- R = Red
- W = White

## 3. Select Optical Block:

- F4 Glass Fiber Optic
- F5 Plastic Fiber Optic
- V4 Convergent Lens, 1.0" Focal Point
- V4A Convergent Lens, 1.0" Focal Point
- V6 Convergent Lens, 1.5" Focal Point
- V8 Convergent Lens, 0.5" Focal Point
- R4 Retroreflective Lens
- R5 Polarized Retroreflective Lens
- O4 Wide Beam Proximity Lens
- O5 Long Range Proximity Lens

**Example:** XPC 4 W F4

X-PRO, Photoelectric Communication Sensor

- 2 = RS-232 MODBUS ASCII
- 3 = RS-232 MODBUS RTU
- 4 = RS-485 MODBUS ASCII
- 5 = RS-485 MODBUS RTU

Light Emitter  
I = Infrared  
R = Red  
W = White

Optical Block

# Hardware & Accessories

## Micro Cable Selection Guide, 8-wire, M12



### TJC-3

T-Junction Cable, 8-pin F, 5-pin M, DB9 for RS-232

### TJC-5

T-Junction Cable, 8-pin F, 5-pin M, DB9 for RS-485

### DCS8-2M

2 meter 8-pin cable

### DCS8-5M

5 meter 8-pin cable

### RDCS8-5M

5 meter 8-pin cable, right angle

### XPC4-DEV

Development Kit for RS-485 Models  
Includes: Software, USB Adaptor, and TJC-5 Cable

### XPC2-DEV

Development Kit for RS-232 Models  
Includes: Software, USB Adaptor, and TJC-3 Cable

## Mounting Brackets

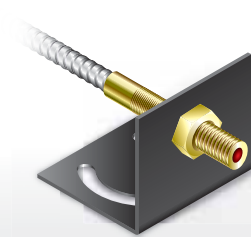

**FMB-1** (8.4 mm diam.)  
Standard Fiberoptic

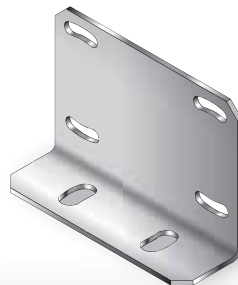

**SEB-3**  
Stainless "L" Bracket

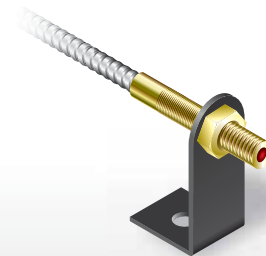

**FMB-2** (5.1 mm diam.)  
**FMB-3** (3.1 mm diam.)  
Miniature Glass or Plastic Fiberoptic

# Specifications



## SUPPLY VOLTAGE

- 10 to 30 VDC
- Polarity Protected
- Intended for use in Class 2 circuits

## CURRENT REQUIREMENTS

- 45mA (exclusive of load)

## OUTPUT TRANSISTORS

- (1) NPN and (1) PNP sensor output transistors
- Outputs sink or source up to 150mA (current limit)
- All outputs are continuously short circuit protected

## REMOTE AUTOSET INPUT/AUX I/O

- Opto-isolated momentary sinking input (10mA)
- Can be configured as INPUT or OUTPUT (PNP Sourcing up to 150mA)

## 2-WIRE COMMUNICATION

- RS-485 or RS-232 models available

## RESPONSE TIME

- 60µs (High Speed Mode)
- 125µs (Standard Mode)
- 450µs (Long Range/High Rez Mode)

## REPEATABILITY

- 20µs (High Speed Mode)
- 25µs (Standard Mode)
- 50µs (Long Range/High Resolution Mode)

## LED LIGHT SOURCE

- Infrared = 880 nm, Red = 660 nm, White = Broadband Color Spectrum

## PUSHBUTTON CONTROL

- AUTOSET
  - Manual Adjustments
  - Set status of options: 10) Lock, 5–1) Five Memory Locations
- NOTE: Any changes to the sensor will automatically be saved to current MEM # location.*

## HYSTERESIS

- Software Configured by User; Factory Default Setting = 1. (See EyewareXPC Help for details)

## LIGHT IMMUNITY

- Responds to sensor's pulsed modulated light source – immune to most ambient light including indirect sunlight

## DIAGNOSTIC INDICATORS

- 10-LED dual-function bar graph operates in one of two modes:
  1. Contrast Indicator – Displays scaled reading of sensor's response to contrasting light levels (light to dark)
  2. Status Indicator – Displays status of selectable options
- Red LED Output Indicator – Illuminates when the sensor's output transistors are "ON"
 

*NOTE: If Output LED flashes, a short circuit condition exists.*
- Amber LED – Illuminates when Action Alert occurs
- Yellow LED – Illuminates during Com Activity and/or when Lock feature is enabled

- Blue LED Output Indicator - Illuminates when output is "ON" Flashes when **Locate** button activated on EyewareXPC Screen 2

## AMBIENT TEMPERATURE

- 0°C to 70°C (32°F to 158°F)

## RUGGED CONSTRUCTION

- Chemical resistant, high impact polycarbonate housing
- Waterproof ratings: NEMA 4X, 6P and IP67
- Conforms to heavy industry grade CE requirements

Patents No. 5,621,205 and No. 6,250,778

RoHS Compliant  
Product subject to change without notice

## Connections and Dimensions

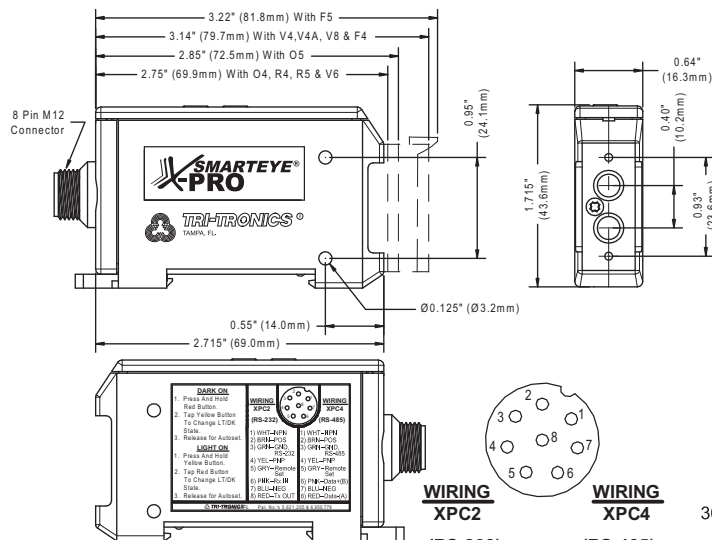

### WIRING XPC2

(RS-232)

- 1) WHT--NPN
- 2) BRN--POS
- 3) GRN--GND, RS-232
- 4) YEL--PNP
- 5) GRY--Remote Set
- 6) PNK--Rx IN
- 7) BLU--NEG
- 8) RED--Tx OUT

### WIRING XPC4

(RS-485)

- 1) WHT--NPN
- 2) BRN--POS
- 3) GRN--GND, RS-485
- 4) YEL--PNP
- 5) GRY--Remote Set
- 6) PNK--Data+(B)
- 7) BLU--NEG
- 8) RED--Data-(A)

## SMARTEYE® X-PRO XPC

P/N SEB-3  
Optional Mounting  
Bracket With Hardware

